



# **NGFW Manager and VPN Broker**

**6.8**

**Product Guide**

© 2020 Forcepoint

Forcepoint and the FORCEPOINT logo are trademarks of Forcepoint.  
All other trademarks used in this document are the property of their respective owners.

Published 18 June 2020

Every effort has been made to ensure the accuracy of this document. However, Forcepoint makes no warranties with respect to this documentation and disclaims any implied warranties of merchantability and fitness for a particular purpose. Forcepoint shall not be liable for any error or for incidental or consequential damages in connection with the furnishing, performance, or use of this manual or the examples herein. The information in this documentation is subject to change without notice.

# Contents

<b>Preface</b> .....	5
<b>Getting started</b> .....	7
<b>1 Getting started with the Forcepoint NGFW Manager and the VPN Broker</b> .....	9
Parts of the NGFW Manager user interface.....	9
<b>VPN Broker configuration</b> .....	17
<b>2 Configuring a single VPN Broker</b> .....	19
Getting started with the VPN Broker.....	19
Single VPN Broker configuration overview.....	22
Start the NGFW Manager.....	23
Select the mode in the NGFW Manager.....	24
Configure an interface for members of the VPN Broker domain.....	25
Create elements for the VPN Broker configuration in the NGFW Manager.....	28
Export the VPN Broker Domain element to a file.....	35
Enable the VPN configuration in the NGFW Manager.....	36
Create elements for the VPN Broker configuration in the SMC.....	37
Check the status of the VPN Broker.....	43
<b>3 Configuring VPN Broker high availability</b> .....	45
Getting started with VPN Broker high availability.....	45
VPN Broker high availability configuration overview.....	49
Start the NGFW Manager.....	50
Select the mode in the NGFW Manager.....	51
Configure an interface for members of the VPN Broker domain.....	52
Create elements for the VPN Broker high availability configuration in the NGFW Manager.....	55
Export a VPN Broker Domain element to a file for high availability.....	65
Enable the VPN configuration in each NGFW Manager.....	66
Create elements for the VPN Broker high availability configuration in the SMC.....	67
Check the status of the VPN Broker.....	73
<b>Local management of a single NGFW Engine</b> .....	75
<b>4 Setting up the NGFW Engine for local management</b> .....	77
Example deployment scenario for a single NGFW Engine.....	77
Limitations of local management of single NGFW Engines.....	78
NGFW Engine configuration overview.....	78
Start the NGFW Manager.....	79
Select the mode in the NGFW Manager.....	80
Create elements to use for NGFW Engine configuration.....	81
Configure interfaces for connections to other networks.....	82
Edit the Access policy.....	85
Edit the NAT policy.....	88

Select the Inspection policy for the NGFW Engine.....	90
Configure SSH access to the NGFW Engine command line.....	90
Configure NTP.....	91
Configure DNS.....	92
Configure the NGFW Engine tester.....	93
Change the IP address of the interface for control connections.....	99
Create other elements for NGFW Engine configuration.....	100
<b>5 Monitoring the NGFW Engine.....</b>	<b>103</b>
Browse log data.....	103
<b>6 Configuring other NGFW Engine properties.....</b>	<b>105</b>
Configure general settings for the NGFW Engine.....	105
Configure policy settings for the NGFW Engine.....	106
VPN settings for the NGFW Engine.....	108
Add-ons for the NGFW Engine.....	108
<b>Maintenance.....</b>	<b>109</b>
<b>7 Maintenance tasks.....</b>	<b>111</b>
Upload, import, and activate dynamic update packages.....	111
Upgrade a single NGFW Engine.....	112
Change your password.....	114
Export elements.....	114
Import elements.....	115
Back up system configurations.....	115
Restore backups.....	116
Restart the NGFW Engine.....	117
Turn off the NGFW Engine.....	117
Collect information for Forcepoint support.....	118
Reset the NGFW appliance to default settings.....	118

# Preface

This guide provides the information you need to work with your Forcepoint product.

## Find product documentation

---

On the Forcepoint support website, you can find information about a released product, including product documentation, technical articles, and more.

You can get additional information and support for your product on the Forcepoint support website at <https://support.forcepoint.com>. There, you can access product documentation, release notes, Knowledge Base articles, downloads, cases, and contact information.

You might need to log on to access the Forcepoint support website. If you do not yet have credentials, create a customer account. See <https://support.forcepoint.com/CreateAccount>.

## Links to downloads

---





NGFW Engine upgrades and dynamic update packages are available at these websites.

- NGFW Engine upgrade downloads: <https://support.forcepoint.com/Downloads>
- Dynamic update package downloads: <https://https://dep-downloads.ngfw.forcepoint.com>

## Conventions

---

The following typographical conventions and icons are used.

<i>Book title, term, emphasis</i>	Title of a book, chapter, or topic; a new term; emphasis.
<b>Bold</b>	Text that is strongly emphasized.
User input, code, message	Commands and other text that the user types; a code sample; a displayed message.
Interface text	Words from the product interface like options, menus, buttons, and dialog boxes.
<a href="#">Hypertext</a>	A link to a topic or to an external website.
	<b>Note:</b> Additional information, like an alternate method of accessing an option.
	<b>Tip:</b> Suggestions and recommendations.
	<b>Important/Caution:</b> Valuable advice to protect your computer system, software installation, network, business, or data.
	<b>Warning:</b> Critical advice to prevent bodily harm when using a hardware product.



# Part I

## Getting started

### Contents

- Getting started with the Forcepoint NGFW Manager and the VPN Broker on page 9

You can use the Forcepoint NGFW Manager to configure the VPN Broker or to manage a single Forcepoint Next Generation Firewall (Forcepoint NGFW) Engine.





## Chapter 1

# Getting started with the Forcepoint NGFW Manager and the VPN Broker

### Contents

- [Parts of the NGFW Manager user interface on page 9](#)

The Forcepoint NGFW Manager is the user interface for configuring the VPN Broker. The VPN Broker automatically creates and removes VPN tunnels as needed in full-mesh VPN environments.



#### Note

This document describes the currently supported features and options. Some features and options that are not yet supported might appear in the user interface.

You can alternatively use the Forcepoint NGFW Manager to locally manage a single NGFW Engine.

There are two different modes in the NGFW Manager:

- **VPN Broker Management** — Allows you to configure the VPN Broker. In this mode, elements and options related to the VPN Broker are shown in addition to elements and options related to the management of the NGFW Engine.
- **NGFW Engine Management** — Allows you to locally manage a single NGFW Engine. In this mode, elements and options related to the VPN Broker are not shown.

Before you begin configuring the VPN Broker or a single NGFW Engine, we recommend that you familiarize yourself with the NGFW Manager user interface.

#### Related concepts

[Getting started with the VPN Broker on page 19](#)

[Getting started with VPN Broker high availability on page 45](#)

#### Related information

[Setting up the NGFW Engine for local management on page 77](#)

## Parts of the NGFW Manager user interface

Familiarize yourself with the parts of the NGFW Manager user interface.

The NGFW Manager consists of three main tabs:

- NGFW — Allows you to configure and monitor the NGFW Engine.
- SD-WAN — Shows elements used for configuring the VPN Broker, and for configuring inbound and outbound traffic management.
- Elements — Shows all elements that you can use for configuring the VPN Broker and for local management of a single NGFW Engine.



#### Note

This document describes the currently supported features and options. Some features and options that are not yet supported might appear in the user interface.

## Controls in the NGFW Manager user interface

These general controls are available in both VPN Broker Management mode and NGFW Engine Management mode in all parts of the NGFW Manager user interface.

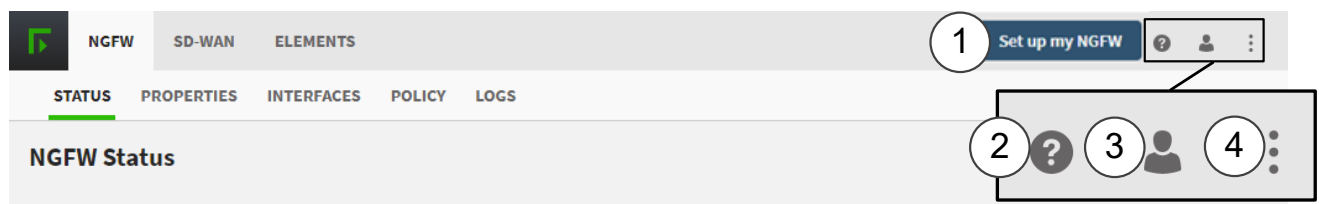

- 1 If you have not yet finished configuring the NGFW Engine, the **Set up my NGFW** wizard guides you through the configuration steps. After you have finished the configuration, the **Publish Changes** button is shown here.
- 2 Opens the online help in a new tab.
- 3 User actions.
  - **Log Out** — Logs you out of the NGFW Manager.
  - **Change Password** — Allows you to change your password.
  - **Mode** — Allows you to select the mode in which to use the NGFW Manager. Modes in the NGFW Manager allow you to either configure the VPN Broker or locally manage a single NGFW Engine.
- 4 Maintenance actions.

## NGFW tab

The NGFW tab allows you to configure and monitor the NGFW Engine.

The NGFW tab consists of the following tabs:

- The **Status** tab shows the status of the NGFW Engine and allows you to control the operation of the NGFW Engine.
- The **Properties** tab allows you to edit the properties of the NGFW Engine.
- The **Interfaces** tab allows you to view and edit the interface configuration of the NGFW Engine.
- The **Policy** tab allows you to view and edit the Access policy and the NAT policy.
- The **Logs** tab allows you to view log and alert entries.

# NGFW > Status tab

The **Status** tab shows the status of the NGFW Engine and allows you to control the operation of the NGFW Engine.

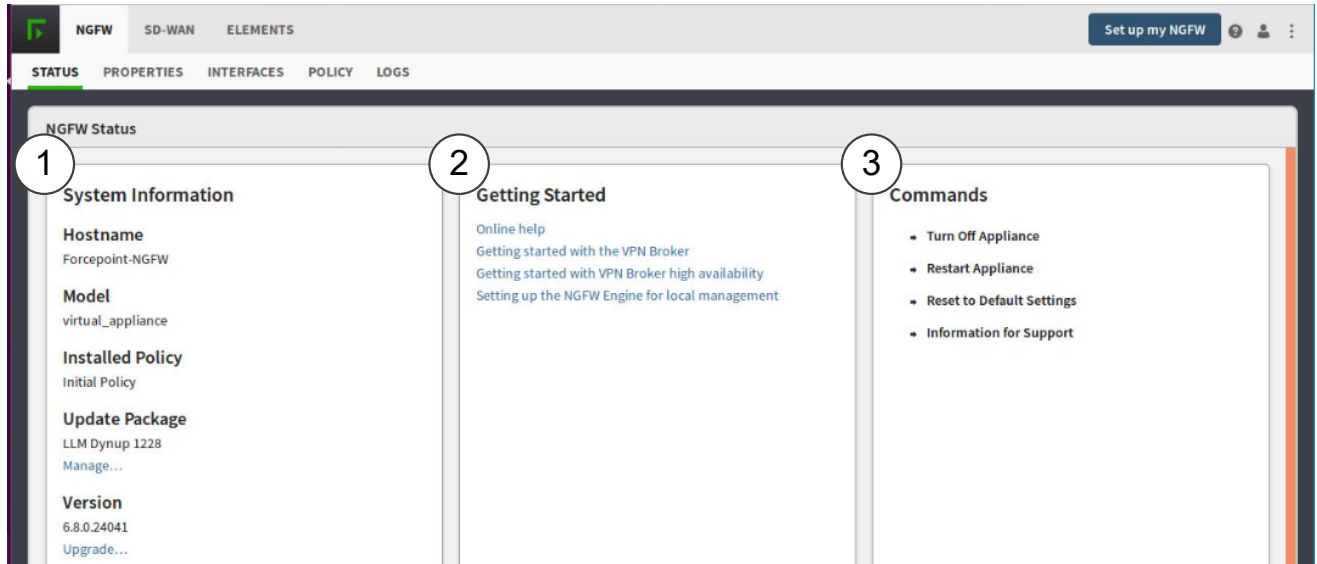

**1** Shows information about the NGFW Engine

Allows you to manage dynamic update packages and upgrade the NGFW Engine.

**2** Links to pages in the online Help that help you get started with the Forcepoint NGFW Manager and the VPN Broker.

**3** Commands for controlling the operation of the NGFW Engine

# NGFW > Properties tab

The **Properties** tab allows you to edit the properties of the NGFW Engine.

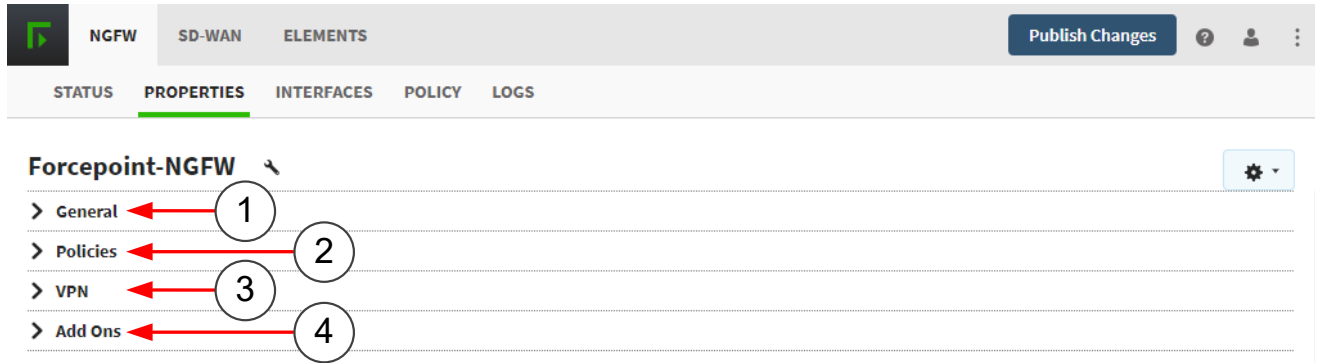

- 1 General settings include high-level properties of the NGFW Engine, the NGFW Engine tester, and settings for NTP and DNS.
- 2 Policy settings specify which policies the NGFW Engine uses, as well as settings for element-based NAT, alias translation, and automatic rules.
- 3 VPN settings for the NGFW Engine



#### Note

VPN settings are only supported for the VPN Broker. VPN settings are not yet supported for local management of single NGFW Engines.

- 4 Add-ons allow you to configure optional features for the NGFW Engine.

## NGFW > Interfaces tab

The **Interfaces** tab allows you to view and edit the interface configuration of the NGFW Engine.

The screenshot shows the 'Forcepoint-NGFW - Interfaces & Routing' page. At the top right, there is a 'Publish Changes' button and a 'New' dropdown menu (1). The main area features a physical diagram of the NGFW appliance (2) with a '51' label. The diagram shows a 12VDC power source, two SFP ports, four Ethernet ports (0, 1, 2, 3), and a CONSOLE port. Below the diagram is a table with the following data:

Physical Interface	IP Address	Connected Network	Gateway	Route Target
Interface 0 External	NDI: 192.168.200.2...	net-192.168.200.0... 192.168.200.0/21	Lab Router 192.168.200.1	

- 1 Allows you to add interfaces to the interface table. Interfaces for each Ethernet port on the NGFW appliance are automatically included in the interface table.  
If you change the number of Ethernet ports on the NGFW appliance, such as by replacing a 4-port interface module with an 8-port interface module, you must add interfaces to represent the new Ethernet ports.
- 2 The image shows the physical ports on the NGFW appliance. When you select an interface in the interface table, the corresponding port is highlighted in the image.
- 3 The interface table allows you to configure the IP addresses, networks, and routing for each interface.

# NGFW > Policy tab

The **Policy** tab allows you to view and edit the Access policy and the NAT policy.

## Access policy

Name	Source	Destination	Service	Logging	Action
Name Connectivity Testing	Address Internal	ANY	Service Port HTTP TLS Match NONE <hr/> Service Port HTTPS	Log Level STORED	Allow

The Access policy defines which connections the NGFW Engine allows. The rules table allows you to add and edit Access rules. By default, the NGFW Engine blocks all connections that have not been specifically allowed in the Access policy.

The Access policy also defines the logging options for traffic. Log entries are shown on the Logs tab.

## NAT policy

Name	NAT Service	NAT Source	NAT Destination
+ Add First Rule			

The NAT policy defines how the NGFW Engine applies network address translation (NAT) to traffic. The rules table allows you to add and edit NAT rules.

# NGFW > Logs tab

The **Logs** tab allows you to view log and alert entries. The Logs tab shows log events in real time as they are created.

Kind	Crea...	Com...	Even...	Sender	Infor...	Facility	Type	Action	Rule...	Src A...	Dst A...	Src P...	Dst P...	IP Pr...	IP Ve...	Event	Situ...	Syslog	Dae...
	27T13:56:42.386Z		2716			g										non-closed	f7-47f9-4d51-8f98-7777720d27b9		
System	2019-02-27T13:	node1	4503600351403940	10.100.1.1	devices added	Syslog	Syslog	added	added	1.1	1.1	1.1	1.1	1.1	1.1	added	added	Kernel messages	kernel

# SD-WAN tab

The SD-WAN tab shows elements used for configuring the VPN Broker, and for configuring inbound and outbound traffic management.

NGFW **SD-WAN** ELEMENTS Publish Changes ? 👤 ⋮

---

STATUS PROPERTIES INTERFACES POLICY **SD-WAN**

**Log events**

Kind	Crea...	Com...	Even...	Sender	Infor...	Facility	Type	Action	Rule...	Src A...	Dst A...	Src P...	Dst P...	IP Pr...	IP Ve...	Event	Situ...	Syslog	Dae...
	27T13:56:42.386Z		2716			g										non-closed	f7-47f9-4d51-8f98-7777720d27b9		
System	2019-02-27T13:	node1	4503600351403940	10.100.1.1	devices added	Syslog	Syslog	added	added	1.1	1.1	1.1	1.1	1.1	1.1	added	added	Kernel messages	kernel

NGFW **SD-WAN** ELEMENTS Publish Changes ? 👤 ⋮

---

STATUS PROPERTIES INTERFACES POLICY **SD-WAN**

Type to filter

- > VPN Broker
  - Policy-Based VPN
  - Route-Based VPN
  - VPN Gateway
- > Other SD-WAN Elements

# Elements tab

The Elements tab shows all elements that you can use for configuring the VPN Broker and for local management of a single NGFW Engine.





# Part II

## VPN Broker configuration

### Contents

- [Configuring a single VPN Broker on page 19](#)
- [Configuring VPN Broker high availability on page 45](#)

You can configure the VPN Broker as a single VPN Broker or as part of a high availability VPN Broker configuration.



## Chapter 2

# Configuring a single VPN Broker

### Contents

- Getting started with the VPN Broker on page 19
- Single VPN Broker configuration overview on page 22
- Start the NGFW Manager on page 23
- Select the mode in the NGFW Manager on page 24
- Configure an interface for members of the VPN Broker domain on page 25
- Create elements for the VPN Broker configuration in the NGFW Manager on page 28
- Export the VPN Broker Domain element to a file on page 35
- Enable the VPN configuration in the NGFW Manager on page 36
- Create elements for the VPN Broker configuration in the SMC on page 37
- Check the status of the VPN Broker on page 43

The VPN Broker creates highly-scalable, full-mesh VPN environments. VPN tunnels are automatically created between NGFW Engines when they communicate with each other. The VPN tunnels are automatically removed when they are no longer needed.

You can configure the VPN Broker in the NGFW Manager on a dedicated Forcepoint NGFW appliance. The VPN Broker is a component of Forcepoint NGFW.



#### Note

This document describes the currently supported features and options. Some features and options that are not yet supported might appear in the user interface.

## Getting started with the VPN Broker

The VPN Broker environment consists of a VPN Broker domain, a VPN Broker gateway, and several VPN Broker members.

- VPN Broker domain — The VPN Broker domain is a virtual network that contains the VPN Broker gateway and the VPN Broker members.
- VPN Broker gateway — The VPN Broker gateway is configured on a single pre-installed Forcepoint NGFW appliance that is dedicated for use only with the VPN Broker.
- VPN Broker member — Each VPN Broker member is an NGFW Engine in the Firewall/VPN role (Single Firewall or Firewall Cluster). When you use Master NGFW Engines and Virtual NGFW Engines, the same Master NGFW Engine can host VPN Broker members that belong to more than one VPN Broker domain. VPN tunnels can be created between VPN Broker members that are controlled by different Management Servers. The members do not need to be in the same administrative Domain in the Forcepoint NGFW Security Management Center (SMC).

The following is an example environment for a single VPN Broker configuration.

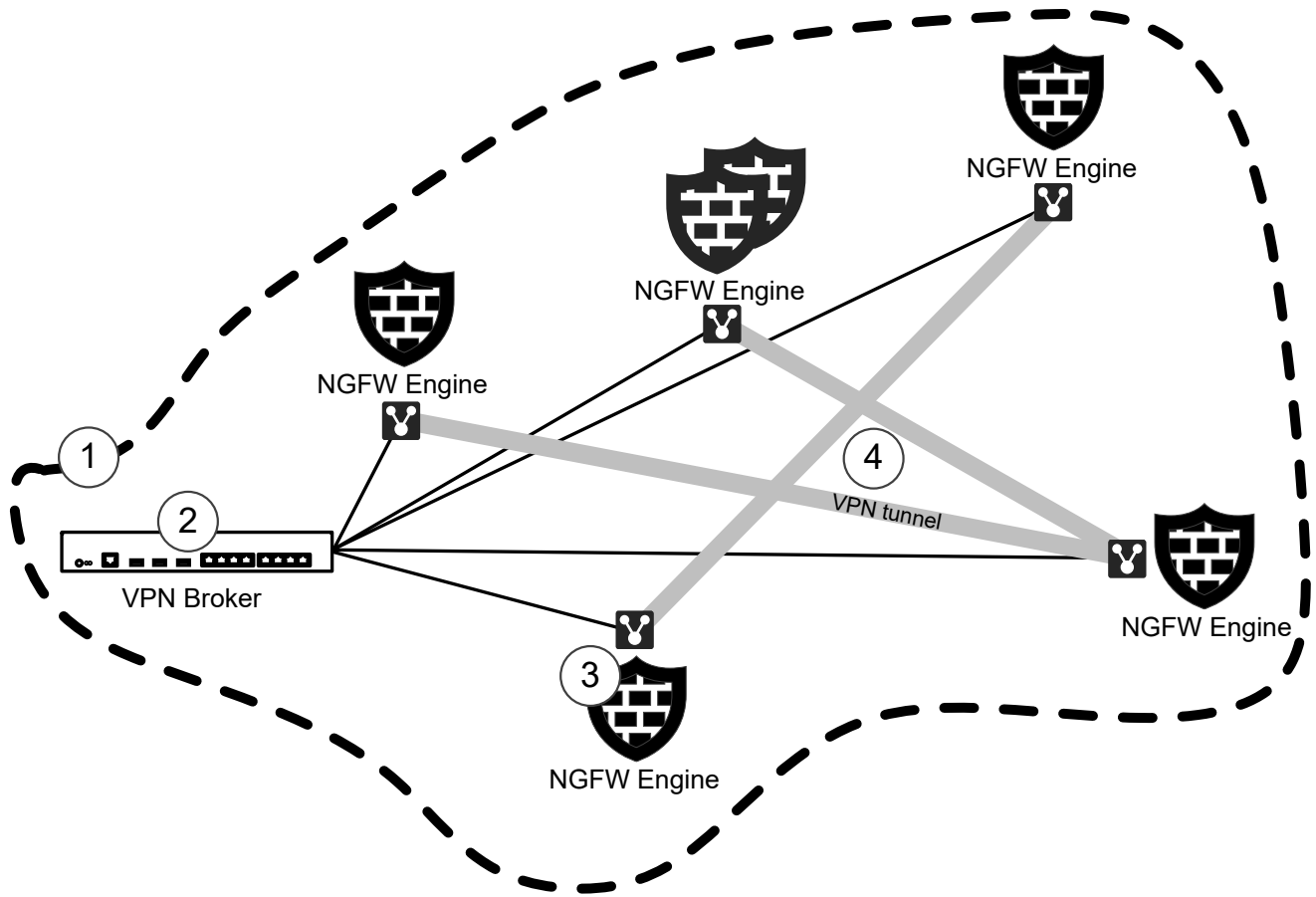

- 1 VPN Broker domain
- 2 VPN Broker gateway  
All members of the domain are connected to the same VPN Broker gateway.
- 3 VPN Broker member
- 4 VPN tunnels are created and removed as needed between the VPN Broker members.

Access rules that allow communication between the VPN Broker gateway and the members are automatically created. The communication between domain members and the VPN Broker gateway is authenticated using a shared secret.

The members communicate with the VPN Broker gateway using a VPN Broker Interface that you must configure on each NGFW Engine. The traffic that goes into the VPN also passes through this interface.

## How the VPN Broker Domain works

The VPN Broker domain is a virtual network that contains the VPN Broker gateway and the VPN Broker members.

The following is an example of IP addresses and MAC addresses in the VPN Broker Domain.

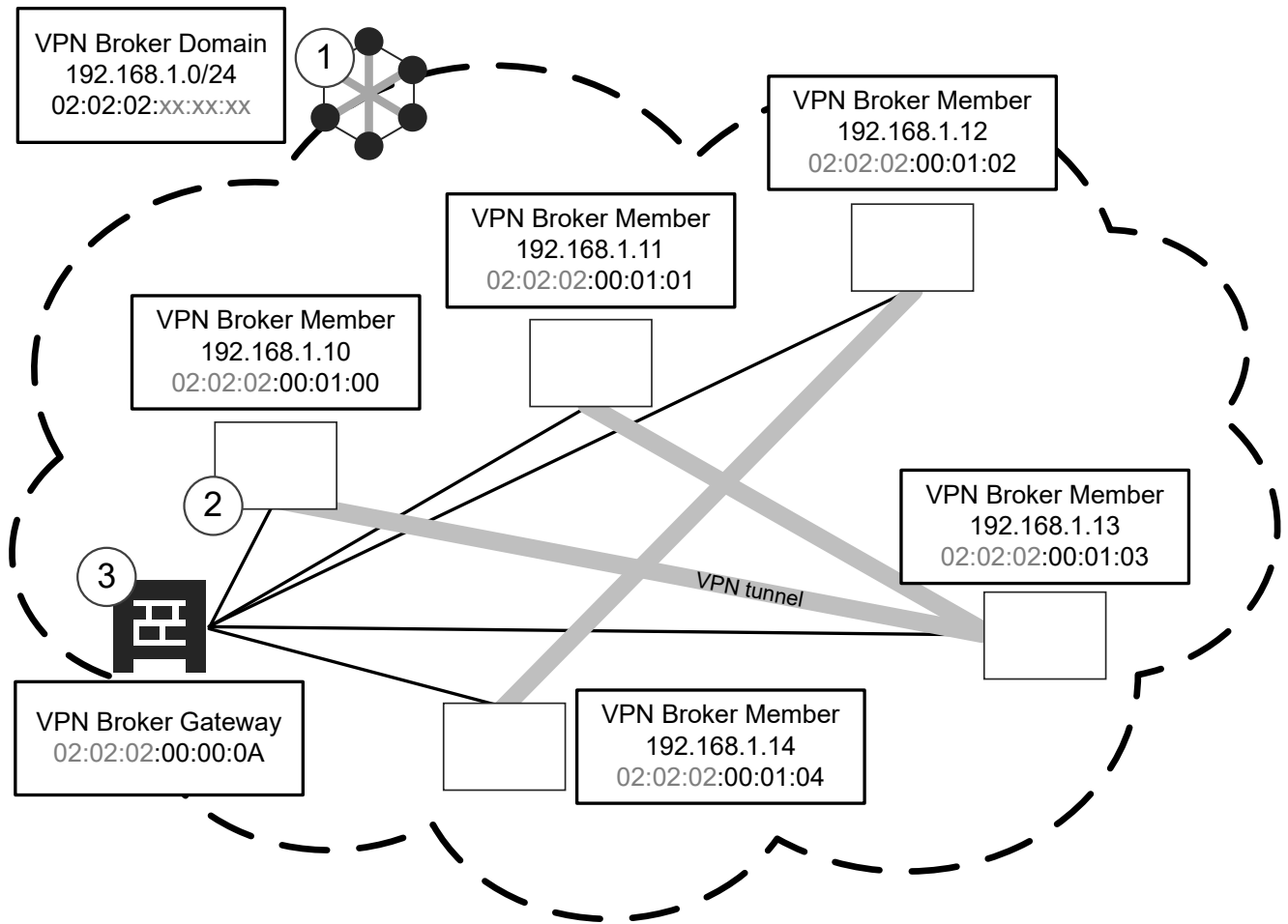

- 1 The VPN Broker Domain is a virtual network.  
The VPN Broker Domain is identified by a unique MAC address prefix. In this example, the MAC address prefix is 02:02:02.
- 2 Each VPN Broker Member has an IP address that is part of the virtual network defined in the VPN Broker Domain.  
Each VPN Broker Member is identified by a unique partial MAC address.
- 3 The VPN Broker Gateway is identified by a unique VPN Broker Gateway ID number.

The MAC address prefix of the VPN Broker Domain is combined with the partial MAC address of each VPN Broker Member to form a complete MAC address for each VPN Broker Member.

**Example of how VPN Broker Member MAC addresses are formed**

MAC address prefix of the VPN Broker Domain	Partial MAC address of the VPN Broker Member	Complete MAC address of the VPN Broker Member
02:02:02	00:01:00	02:02:02:00:01:00
	00:01:01	02:02:02:00:01:01
	00:01:02	02:02:02:00:01:02
	00:01:03	02:02:02:00:01:03
	00:01:04	02:02:02:00:01:04

The MAC address prefix of the VPN Broker Domain is combined with the VPN Broker Gateway ID number to form a complete MAC address for the VPN Broker Gateway.

In this example, the VPN Broker Gateway ID is 10. In the NGFW Manager, you enter the VPN Broker Gateway ID as a decimal number. However, the ID is converted internally to a hexadecimal number. For example, an ID of 10 is converted to 0A in the MAC address of the VPN Broker Gateway.

**Example of how VPN Broker Gateway MAC addresses are formed**

MAC address prefix of the VPN Broker Domain	VPN Broker Gateway ID	Complete MAC address of the VPN Broker Gateway
02:02:02	10	02:02:02:00:00:0A

# Single VPN Broker configuration overview

---

To configure a single VPN Broker, you must complete steps in the NGFW Manager and in the SMC.

## Steps in the NGFW Manager

---

- 1) Start the NGFW Manager, then select VPN Broker Management mode.
- 2) Configure the interface to which members of the VPN Broker domain can connect.
- 3) Create the required elements in the following order:
  - a) VPN Broker Gateway
  - b) VPN Broker Domain
  - c) VPN Broker Member
- 4) Export the VPN Broker Domain element to a file.
- 5) Enable the VPN configuration.

## Steps in the Management Client component of the SMC

---

- 1) Create the required elements in the following order:
  - a) Create a VPN Broker Domain element.
  - b) Add a VPN Broker Interface to the NGFW Engine.
- 2) Refresh the firewall policy.

**Note**

VPN Broker provides connectivity between networks of the VPN Broker members. You must add Access rules to the policy of each NGFW Engine to allow specific types of traffic to and from these networks.

## Next steps

---

Begin the configuration by starting the NGFW Manager.

# Start the NGFW Manager

---

The NGFW Configuration Wizard allows you to configure settings for the Forcepoint NGFW appliance. Start the NGFW Manager from the web browser version of the NGFW Configuration Wizard.

## Steps

- 1) Connect the NGFW appliance to a laptop or other client device.  
Connect an Ethernet cable from the client device to physical port eth0\_1 on the NGFW appliance. If the NGFW appliance does not have a port eth0\_1, use port eth1\_0. If using non-modular interfaces, use port eth1.
- 2) Connect the other network cables to the Forcepoint NGFW appliance.
- 3) Turn on the Forcepoint NGFW appliance.
- 4) To start the web browser version of the NGFW Configuration Wizard, open a web browser on the client device, then connect to <https://169.254.169.169>.  
It might take some time for the web page to load.
- 5) When the NGFW Configuration Wizard offers a web browser client certificate, accept the certificate.
- 6) On the Welcome page of the NGFW Configuration Wizard, click **Start**.
- 7) Select **I Agree to the Terms and Conditions**, then click **Next**.

- 8) Enter and confirm the password for the root account, then click **Next**.

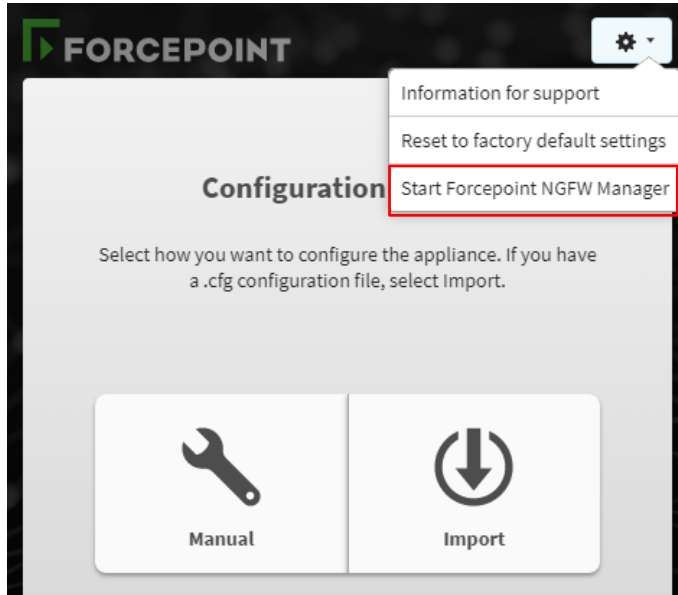

- 9) Click **⚙** > **Start Forcepoint NGFW Manager** to restart the appliance.
- 10) After the NGFW appliance has restarted, refresh the web browser to start the NGFW Manager.
- 11) Enter `root` as the user name, enter the password for the root account, then click **Log In**.

## Next steps

Continue by selecting the mode in the NGFW Manager.

# Select the mode in the NGFW Manager

Modes in the NGFW Manager allow you to either configure the VPN Broker or locally manage a single NGFW Engine.

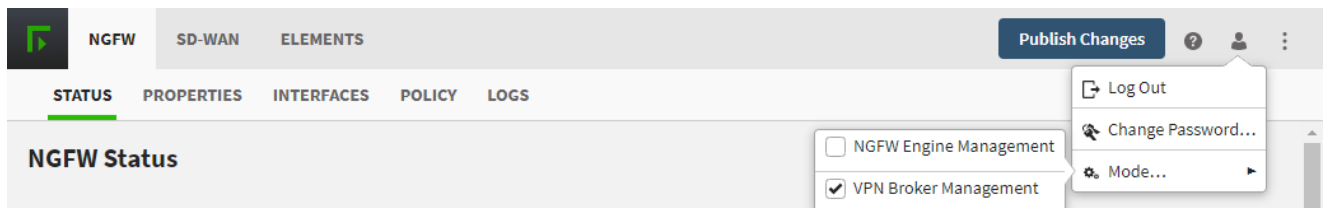

## Steps

- 1) Select **User** > **⚙** **Mode**, then select the mode.
- **VPN Broker Management** — Allows you to configure the VPN Broker. In this mode, elements and options related to the VPN Broker are shown in addition to elements and options related to the management of the NGFW Engine.



- **NGFW Engine Management** — Allows you to locally manage a single NGFW Engine. In this mode, elements and options related to the VPN Broker are not shown.

## Next steps

Continue the configuration in one of the following ways:

- If you are configuring the VPN Broker, configure an interface for members of the VPN Broker domain.
- If you are locally managing a single NGFW Engine, create elements to use for NGFW Engine configuration.

# Configure an interface for members of the VPN Broker domain

Interfaces for each Ethernet port on the NGFW appliance are automatically included in the interface table. You must add an IP address for the interface to which members of the VPN Broker domain connect.

## Before you begin

Start the NGFW Manager, then select VPN Broker Management mode.

## Steps

- 1) Browse to **NGFW > Interfaces**.

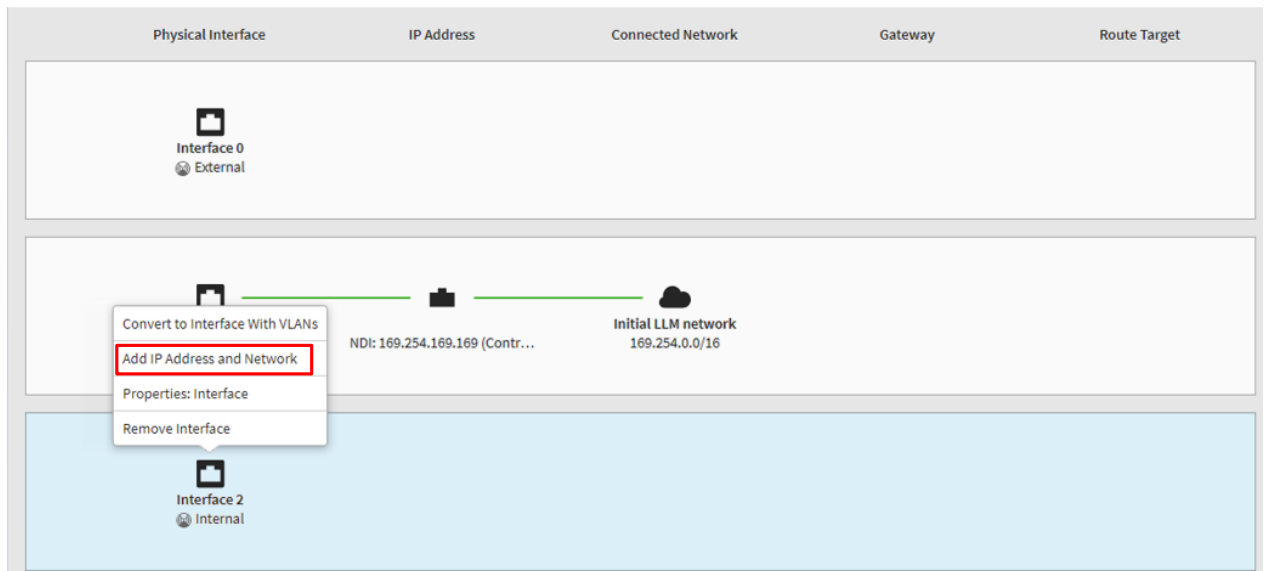

- 2) In the interface table below the appliance image, click an interface, then select **Add IP Address and Network**.

- 3) Enter the IP address and netmask to which members of the VPN Broker domain can connect in CIDR notation, then click **Save**.

Fields marked with an asterisk \* in the user interface are mandatory.

Interfaces & Routing page	
Option	Definition
New	<p>Adds an interface to the interfaces table. If you change the number of Ethernet ports on the NGFW appliance, such as by replacing a 4-port interface module with an 8-port interface module, you must add interfaces to represent the new Ethernet ports.</p> <ul style="list-style-type: none"> <li>■ <b>Interface</b> — Adds a physical interface. Opens the <b>New Interface</b> dialog.</li> <li>■ <b>Interface with VLANs</b> — Adds a physical interface with a placeholder for adding VLAN interfaces later. Opens the <b>New Interface With VLANs</b> dialog.</li> <li>■ <b>Tunnel Interface</b> — This option is not yet supported.</li> </ul>
Appliance image	Shows the ports on the NGFW appliance for which you can configure interfaces. When you select an interface in the interface table, the corresponding port is highlighted in the image.
Interface table	Allows you to configure the IP addresses, networks, and routing for each interface.
Physical Interface	<p><i>(When interface type is Physical Interface)</i></p> <p>Shows the interface ID of the physical interfaces. The following actions are available when you click the interface:</p> <ul style="list-style-type: none"> <li>■ <b>Add IP Address and Network</b> — Adds an IP address and a Network element to the interface. Opens the <b>New IP Address and Netmask</b> dialog box.</li> <li>■ <b>Convert to Interface With VLANs</b> — Removes any IP addresses that have been specified and converts the interface to an interface with VLANs.</li> <li>■ <b>Properties: Interface</b> — Opens the interface properties.</li> <li>■ <b>Remove Interface</b> — Removes the interface from the configuration.</li> </ul>
Physical Interface	<p><i>(When interface type is Physical Interface with VLAN interfaces)</i></p> <p>Shows the interface ID of the physical interfaces and the VLAN interfaces under them. The following actions are available when you click the physical interface:</p> <ul style="list-style-type: none"> <li>■ <b>Add VLAN Interface</b> — Adds a VLAN interface.</li> <li>■ <b>Convert to Interface</b> — Converts the interface with VLANs to an interface. There can be a maximum of one VLAN Interface when you convert the interface.</li> <li>■ <b>Properties: Interface with VLANs</b> — Opens the interface properties.</li> <li>■ <b>Remove Interface</b> — Removes the interface from the configuration.</li> </ul> <p>The following actions are available when you click the VLAN interface:</p> <ul style="list-style-type: none"> <li>■ <b>Add IP Address and Network</b> — Adds an IP address and a Network element to the interface. Opens the <b>New IP Address and Netmask</b> dialog box.</li> <li>■ <b>Properties: VLAN Interface</b> — Opens the VLAN interface properties.</li> <li>■ <b>Remove VLAN Interface</b> — Removes the VLAN interface.</li> </ul>
IP Address	<p>Shows the IP address of the physical interface or VLAN interface. The following actions are available when you click the IP address:</p> <ul style="list-style-type: none"> <li>■ <b>Properties: Static Address</b> — Allows you to add a static IP address to the interface.</li> <li>■ <b>Remove IP Address and Network</b> — Removes the IP address from the interface configuration.</li> </ul>

Option	Definition
<b>Connected Network</b>	Shows the network range of the directly connected network. The following options are available when you click the network: <ul style="list-style-type: none"> <li>■ <b>Add Gateway</b> — Allows you to add a route through a gateway device to a network that is not directly connected.</li> <li>■ <b>Properties: Network</b> — Opens the properties of the Network element.</li> </ul>
<b>Gateway</b>	Shows the gateway device through which the NGFW Engine connects to a network that is not directly connected. The following actions are available when you click the gateway: <ul style="list-style-type: none"> <li>■ <b>Add Route Target</b> — Allows you to specify the IP addresses that are reachable through the gateway device.</li> <li>■ <b>Properties: &lt;element type&gt;</b> — Opens the properties of the element that represents the gateway device.</li> <li>■ <b>Remove Gateway</b> — Removes the gateway device from the interface configuration. The element is not deleted.</li> </ul>
<b>Route Target</b>	Shows the IP addresses that are reachable through the gateway device. The following options are available when you click the route target: <ul style="list-style-type: none"> <li>■ <b>Properties: &lt;element type&gt;</b> — Opens the properties of the element that represents the IP addresses.</li> <li>■ <b>Remove Route Target</b> — Removes the route target from the interface configuration. The element is not deleted.</li> </ul>

### Interface properties

Option	Definition
<b>Interface ID</b>	<i>(When interface type is Physical Interface)</i> The Interface ID automatically maps to a physical network port on the appliance.
<b>VLAN ID</b>	<i>(When interface type is VLAN Interface)</i> Specifies the VLAN ID (1–4094). The VLAN IDs must be the same as the VLAN IDs that are used in the switch at the other end of the VLAN trunk. Each VLAN Interface is identified as Interface-ID.VLAN-ID, for example, 2.100 for Interface ID 2 and VLAN ID 100.
<b>Interface Options (Optional)</b>	Advanced options for interface configuration.
<b>MTU</b>	The maximum transmission unit (MTU) size on the connected link. Enter a value between 576–65000.
<b>Zone</b>	The network zone to which the interface belongs. By default, Interface 0 belongs to the external zone. All other interfaces belong to the internal zone.
<b>Antispoofing Elements</b>	This option is not yet supported.
<b>Route Replies Back</b>	This option is not yet supported.

## Next steps

Create elements for the VPN Broker configuration in the NGFW Manager.

# Create elements for the VPN Broker configuration in the NGFW Manager

You must create the elements that represent the VPN Broker configuration in the NGFW Manager.

The following elements are used in the configuration:

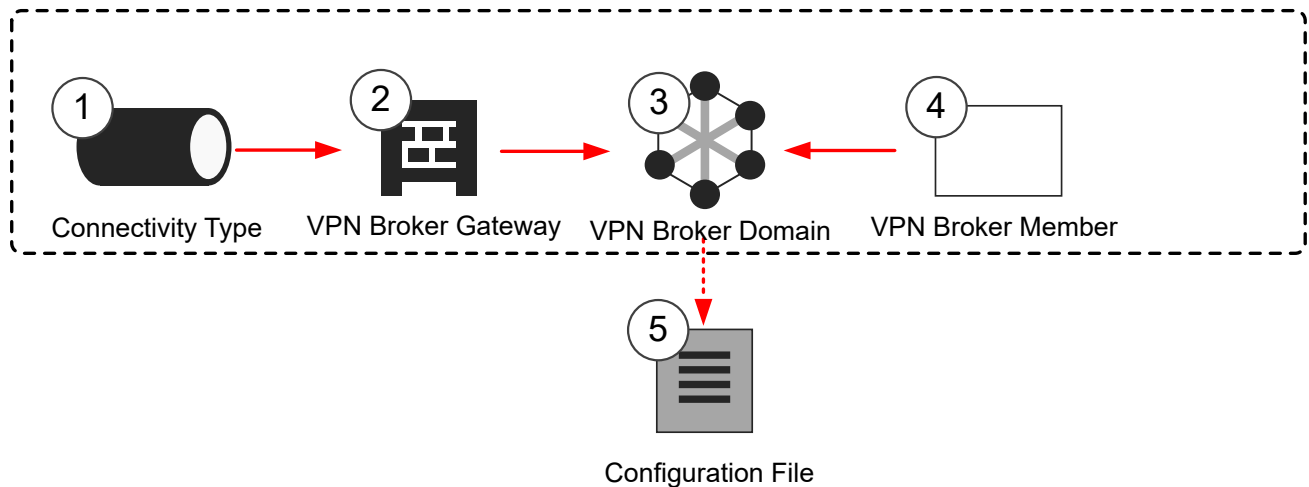

- 1 Connectivity Type elements define the connectivity group to which endpoints belong, and the mode used when an endpoint is part of a Multi-Link configuration.  
The default system Connectivity Type elements belong to connectivity group 1. If you need to use a different connectivity group, create a custom Connectivity Type element.
- 2 The VPN Broker Gateway element represents the VPN Broker and contains information about the available endpoints.
- 3 The VPN Broker Domain is used to group all the VPN Broker members in a single domain.
- 4 A VPN Broker Member element represents each NGFW Engine.
- 5 The configuration file for the VPN Broker Domain is exported from the NGFW Manager.

## Next steps

Begin the configuration in one of the following ways:

- If you need a custom Connectivity Type element, create a Connectivity Type element.
- Otherwise, create a VPN Broker Gateway element.

## Create Connectivity Type elements in the NGFW Manager

Connectivity Type elements define the connectivity group to which endpoints belong, and the mode used when an endpoint is part of a Multi-Link configuration. If the default Connectivity Type elements meet your needs, it is not necessary to create custom Connectivity Type elements.

The default system Connectivity Type elements belong to connectivity group 1. If you need to use a different connectivity group, create a custom Connectivity Type element.

## Steps

- 1) Browse to **SD-WAN > Other SD-WAN Elements > Connectivity Type**.

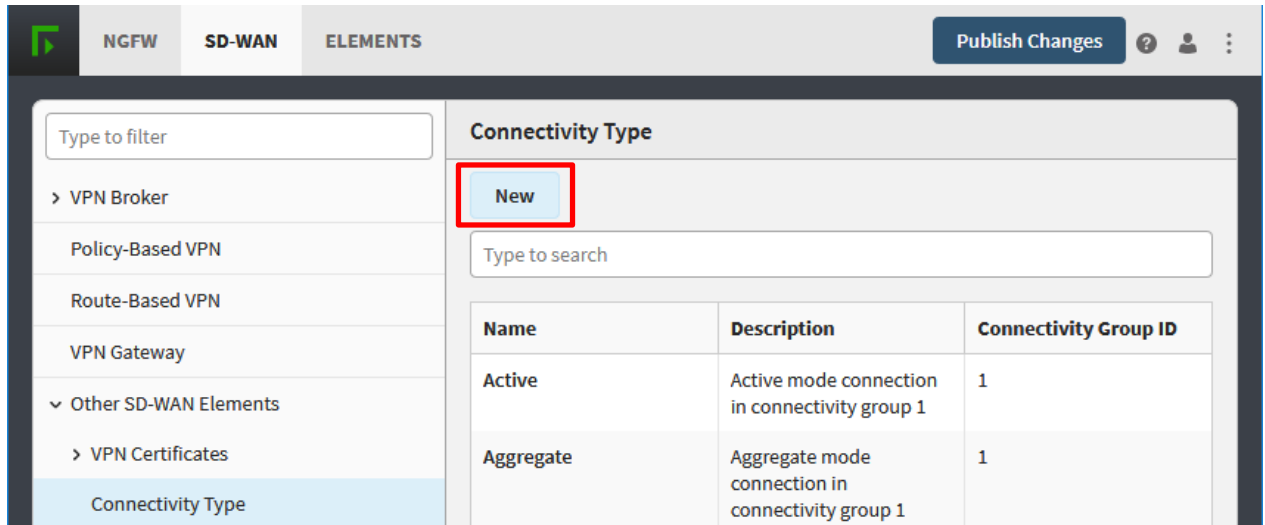

- 2) Click **New**.
- 3) Configure the settings, then click **Save**.

Fields marked with an asterisk \* in the user interface are mandatory.

Connectivity Type Properties	
Option	Definition
<b>Mode</b>	Select one of the options to define how the endpoint is used in a Multi-Link configuration: <ul style="list-style-type: none"> <li>■ <b>Active</b> — The link is always used. If there are multiple links in Active mode between the Gateways, the VPN traffic is load-balanced between the links based on the load of the links. VPN traffic is directed to the link that has the lowest load.</li> <li>■ <b>Aggregate</b> — The link is always used, and each VPN connection is load-balanced in round-robin fashion between all the links that are in Aggregate mode. For example, if there are two links in Aggregate mode, a new VPN connection is directed to both links.</li> <li>■ <b>Standby</b> — The link is used only when all Active or Aggregate mode links are unusable.</li> </ul>
<b>Connectivity Group ID</b>	Enter or select the number of the connectivity group to which the endpoint belongs. Tunnels are created only between endpoints that belong to the same connectivity group.
<b>Link Type</b>	This option is not yet supported.

## Next steps

Create a VPN Broker Gateway element.

# Create a VPN Broker Gateway element in the NGFW Manager

The VPN Broker Gateway element defines the endpoints used in the configuration. The same VPN Broker gateway can belong to more than one VPN Broker domain.

## Steps



- 1) Browse to **SD-WAN > VPN Broker > VPN Broker Gateway**.



- 2) Click **New > VPN Broker Gateway**.
- 3) Add a row in one of the following ways:
  - Click **...** > **Add VPN Endpoint** to add the first row.
  - Click **...** > **New > VPN Broker Endpoint Before** to add a row above the selected row.
  - Click **...** > **New > VPN Broker Endpoint After** to add a row below the selected row.
- 4) Configure the settings, then click **Save**.

Fields marked with an asterisk **\*** in the user interface are mandatory.

VPN Broker Gateway properties	
Option	Definition
<b>Endpoints table</b> To edit the contents of a cell, click the cell. Click <b>...</b> > <b>New &gt; VPN Broker Endpoint Before</b> or <b>...</b> > <b>New &gt; VPN Broker Endpoint After</b> to add a row.	
<b>Info</b>	You can enter a name and a comment for the endpoint.
<b>Endpoint Address</b>	Select <b>NGFW Engine IP Address</b> , select <b>Static Address</b> , then select an element from the <b>Static IP Address</b> folder that represents the interface to use for the endpoint. Type part of the name of an element or browse through the drop-down list to select an element.

Option	Definition
<b>Endpoint Class</b>	<p>Select a default system Connectivity Type element that has the appropriate mode selected. Type part of the name of an element or browse through the drop-down list to select an element.</p> <p>The following system Connectivity Type elements are available:</p> <ul style="list-style-type: none"> <li>■ <b>Active</b> — The link is always used. If there are multiple links in Active mode between the Gateways, the VPN traffic is load-balanced between the links based on the load of the links. VPN traffic is directed to the link that has the lowest load.</li> <li>■ <b>Aggregate</b> — The link is always used, and each VPN connection is load-balanced in round-robin fashion between all the links that are in Aggregate mode. For example, if there are two links in Aggregate mode, a new VPN connection is directed to both links.</li> <li>■ <b>Standby</b> — The link is used only when all Active or Aggregate mode links are unusable.</li> </ul>
<b>Enabled</b>	When selected, the endpoint is enabled. You can temporarily disable the endpoint without deleting it.
<b>Used for Client Gateways</b>	When <b>Yes</b> is selected, VPN Broker members can communicate using the endpoint. If there is an intermediate NAT device between this VPN Broker and VPN Broker members, add a contact address.
<b>Used for Broker Servers</b>	When <b>Yes</b> is selected, other VPN Broker gateways can communicate using the endpoint. If there is an intermediate NAT device between this VPN Broker and other VPN Broker gateways, add a contact address.
<b>VPN Broker Gateway ID</b>	<p>Enter a unique ID number for the VPN Broker Gateway as an integer. The allowed range is 1–255.</p> <div style="border: 1px solid #ccc; background-color: #f9f9f9; padding: 10px; margin: 10px 0;"> <p> <b>Note</b></p> <p>In the NGFW Manager, you enter the VPN Broker Gateway ID as a decimal number. However, the ID is converted internally to a hexadecimal number. For example, an ID of 10 is converted to 0A in the MAC address of the VPN Broker Gateway. The allowed range in hexadecimal numbers is 1–FF.</p> </div> <p>When a log entry is generated, the SMC uses this value to identify the VPN Broker that generated the log entry.</p> <div style="border: 1px solid #ccc; background-color: #f9f9f9; padding: 10px; margin: 10px 0;"> <p> <b>Tip</b></p> <p>We recommend that you make a note of the VPN Broker Gateway ID for each VPN Broker Gateway.</p> </div>

## Next steps

Create a VPN Broker Domain element.

# Create a VPN Broker Domain element in the NGFW Manager

VPN Broker Domain element defines the virtual network that contains the VPN Broker gateway and the VPN Broker members.

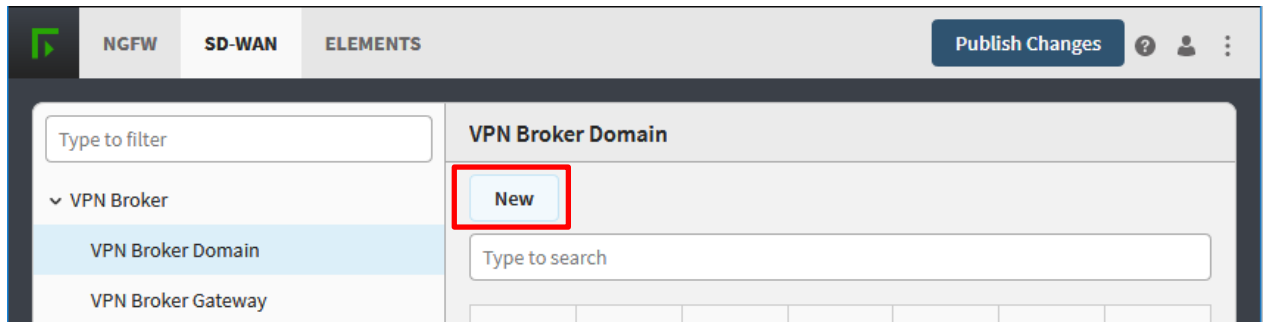

## Steps

- 1) Browse to **SD-WAN > VPN Broker > VPN Broker Domain**.



- 2) Click **New**.
- 3) Configure the settings, then click **Save**.

Fields marked with an asterisk \* in the user interface are mandatory.

VPN Broker Domain properties	
Option	Definition
<b>IPv4 Network or IPv6 Network</b>	<p>Enter the IP address and netmask of the virtual network that contains all of the members of the VPN Broker domain. You must enter an IPv4 network, an IPv6 network, or both.</p> <p> <b>Tip</b> We recommend that you make a note of the IP addresses for each VPN Broker Domain.</p>
<b>VPN Broker Gateway</b>	Select the VPN Broker Gateway that belongs to the VPN Broker domain. Type part of the name of an element or browse through the drop-down list to select an element.
<b>External VPN Broker Gateways</b>	This setting is used only in a VPN Broker high availability configuration.
<b>MAC Address Prefix</b>	<p>Enter a unique identifier for the VPN Broker Domain in MAC address format. The length must be three octets. The first octet must be even. The address must be a unique unicast MAC address.</p> <p> <b>Tip</b> We recommend that you make a note of the MAC Address Prefix for each VPN Broker Domain.</p>
<b>Primary VPN Broker Server</b>	This setting is used only in a VPN Broker high availability configuration.



Option	Definition
Enabled	When selected, the VPN Broker Domain element is enabled. You can temporarily disable the element without deleting it.

### Next steps

Create VPN Broker Member elements to represent each NGFW Engine that is used in the VPN Broker configuration.

## Create VPN Broker Member elements in the NGFW Manager

Create VPN Broker Member elements to represent each NGFW Engine that is used in the VPN Broker configuration.

### Steps

- 1) Browse to **SD-WAN > VPN Broker > VPN Broker Member**.

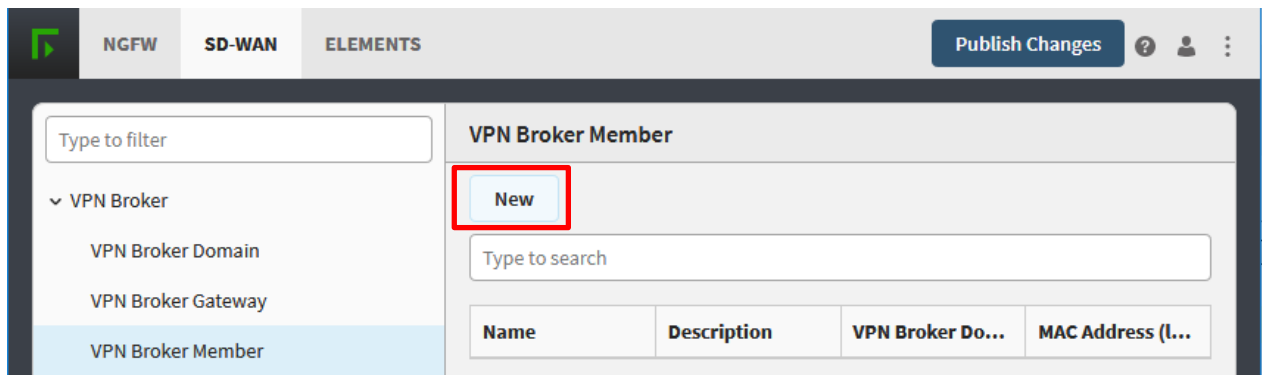

- 2) Click **New**.
- 3) Configure the settings, then click **Save**.

Fields marked with an asterisk \* in the user interface are mandatory.

VPN Broker Member properties	
Option	Definition
VPN Broker Domain	Select the VPN Broker Domain element that you created. Type part of the name of an element or browse through the drop-down list to select an element.

Option	Definition
<p><b>Mac Address (last three octets)</b></p>	<p>Enter a unique identifier for the VPN Broker Member as the last three octets of a MAC address. The allowed range is 00:01:00–ff:ff:ff. Each member in the domain must have a unique identifier. When adding a VPN Broker Interface to an NGFW Engine in the SMC, use the same value that is used in the corresponding VPN Broker Member element in the NGFW Manager.</p> <div data-bbox="451 359 506 411" style="float: left; margin-right: 10px;"></div> <div data-bbox="537 359 1468 485" style="background-color: #f0f0f0; padding: 5px;"> <p><b>Note</b></p> <p>The range 00:00:01– 00:00:FF is reserved for the VPN Broker Gateway element. You cannot use identifiers in this range for members in the domain.</p> </div> <div data-bbox="451 527 490 579" style="float: left; margin-right: 10px;"></div> <div data-bbox="537 527 1468 653" style="background-color: #f0f0f0; padding: 5px;"> <p><b>Tip</b></p> <p>We recommend that you make a note of the MAC addresses for each VPN Broker Member.</p> </div>
<p><b>Shared Secret</b></p>	<p>Click <b>Enter Shared Secret</b> to enter a password. Click <b>Change Shared Secret</b> to change a password that has already been set.</p> <p>When adding a VPN Broker Interface to an NGFW Engine in the SMC, use the same value that is used in the corresponding VPN Broker Member element in the NGFW Manager.</p> <div data-bbox="451 852 490 905" style="float: left; margin-right: 10px;"></div> <div data-bbox="537 852 1468 947" style="background-color: #f0f0f0; padding: 5px;"> <p><b>Tip</b></p> <p>We recommend that you make a note of the shared secret.</p> </div>
<p><b>IPv4 Address or IPv6 Address</b></p>	<p>Enter a member IP address that is part of the virtual network defined in the VPN Broker Domain element. You must enter an IPv4 address, an IPv6 address, or both.</p> <p>Use the same kind of IP address that the VPN Broker Domain uses. For example, if the VPN Broker Domain has only IPv4 addresses, enter an IPv4 address. You can enter both an IPv4 address and an IPv6 address if the VPN Broker Domain has both IPv4 addresses and IPv6 addresses.</p> <div data-bbox="451 1209 490 1262" style="float: left; margin-right: 10px;"></div> <div data-bbox="537 1209 1468 1335" style="background-color: #f0f0f0; padding: 5px;"> <p><b>Tip</b></p> <p>We recommend that you make a note of the IP addresses for each VPN Broker Member.</p> </div>
<p><b>Networks table</b></p> <p>To edit the contents of a cell, click the cell.</p> <p>Click <b>*** &gt; Add</b> to add the first row.</p> <p>Click <b>*** &gt; New &gt; Row Before</b> or <b>*** &gt; New &gt; Row After</b> to add a row.</p>	
<p><b>Network</b></p>	<p>Select the networks that are reachable through the VPN Broker member. Type part of the name of an element or browse through the drop-down list to select an element.</p>

Option	Definition
<b>Mode</b>	<p>Select from the following options.</p> <ul style="list-style-type: none"> <li>■ <b>Reserved</b> — Network addresses are dedicated to the gateway and these addresses or a subnet of these addresses cannot be given to any other member of the VPN Broker domain. This is the recommended option.</li> <li>■ <b>Allowed</b> — Network addresses are allowed for the VPN gateway. However, the VPN Broker does not announce these as routes to other VPN gateways. Used for dynamic routing or the default VPN gateway.</li> <li>■ <b>Routed</b> — When selected, enter a value in the <b>Metric</b> field. The same network address that has a different route metric value can be given to another VPN gateway. The subnet of a specified network can be given to a specified VPN gateway.</li> </ul>

## Next steps

Export the VPN Broker Domain element to a file.

# Export the VPN Broker Domain element to a file

To create the elements needed in the SMC, you must export the VPN Broker Domain element from the NGFW Manager.

## Steps

- 1) Browse to **SD-WAN > VPN Broker > VPN Broker Domain**.

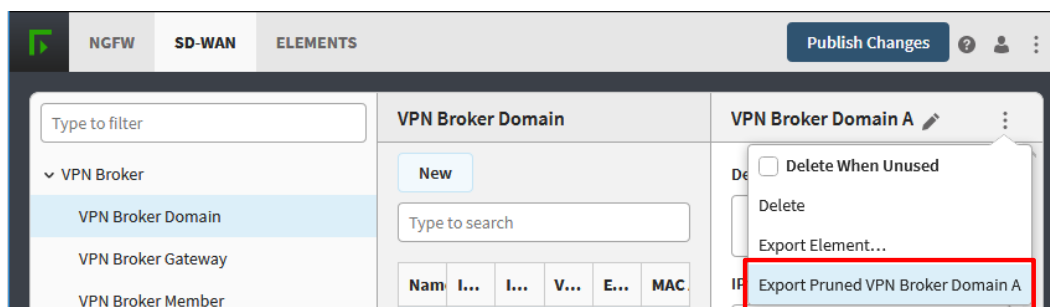

- 2) Select the VPN Broker Domain element that you want to export, then click **:** > **Export Pruned <name>**.  
The **Export Pruned** option exports only the parts of the VPN Broker Domain configuration that are needed for creating a VPN Broker Domain element in the SMC. The exported configuration includes the VPN Broker Domain and the VPN Broker Members.
- 3) Save the .zip file to your local workstation.

## Next steps

Enable the VPN configuration in the NGFW Manager.

# Enable the VPN configuration in the NGFW Manager

The VPN configuration must be enabled in the properties of the NGFW Engine in the NGFW Manager.

## Steps

- 1) Browse to **NGFW > Properties**.
- 2) Browse to the **VPN** section, then select **VPN Configuration**.
- 3) To add a row to the **VPN Gateways** table, click **⋮ > Add**.
- 4) In the **VPN Gateway** cell, add the VPN Broker Gateway element that you created.  
Type part of the name of an element or browse through the drop-down list to select an element.
- 5) Under **VPN Gateway Settings**, add the Gateway Default Settings element.  
Type part of the name of an element or browse through the drop-down list to select an element.
- 6) Click **Save**.
- 7) If you have not yet viewed or edited the Access policy, at the top-right corner of the user interface click:
 

Finalize the setup
- 8) To publish your changes in the NGFW Manager, at the top-right corner of the user interface, click:
 

Publish Changes

Fields marked with an asterisk \* in the user interface are mandatory.

NGFW Engine Properties - VPN	
Option	Definition
<b>VPN Configuration</b>	When selected, enables the VPN options.
<b>VPN Gateways</b>	Shows the configured VPN gateways. Click <b>⋮ &gt; Add</b> to add a row to the table.
<b>Gateway</b>	The VPN Gateway element that represents the physical gateway device. Type part of the name of an element or browse through the drop-down list to select an element.
<b>VPN Client Settings</b>	This option is not yet supported.
<b>SSL VPN Settings</b>	This option is not yet supported.
<b>Automatic Certificate Management</b>	This option is not yet supported.
<b>Automatic Sites From Routing</b>	This option is not yet supported.
<b>VPN Gateway Settings</b>	The VPN Gateway Settings element defines performance-related VPN options. Type part of the name of an element or browse through the drop-down list to select an element.

## Next steps

You have now finished the configuration steps in the NGFW Manager. Next, create elements for the VPN Broker configuration in the SMC.

# Create elements for the VPN Broker configuration in the SMC

After you have finished the configuration steps in the NGFW Manager, you must create the elements that represent the VPN Broker configuration in the SMC.

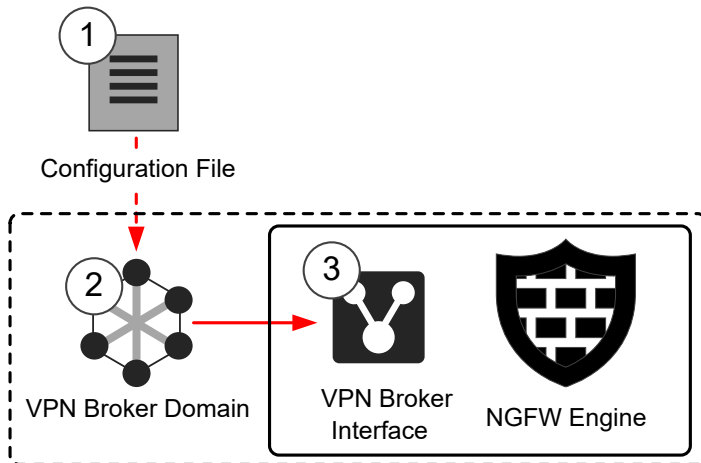

- 1** The configuration file for the VPN Broker Domain is exported from the NGFW Manager.
- 2** The configuration file that you exported from the NGFW Manager is used in the VPN Broker Domain element.
- 3** The VPN Broker Interface is a virtual interface in the configuration of the NGFW Engine. The VPN Broker interface allows the NGFW Engine to act as a member of the VPN Broker domain.

## Next steps

Begin by creating a VPN Broker Domain element in the SMC.



# Create a VPN Broker Domain element in the SMC

To create a VPN Broker Domain element in the SMC, you must use the exported configuration file from the NGFW Manager.

**Steps**  For more details about the product and how to configure features, click **Help** or press **F1**.

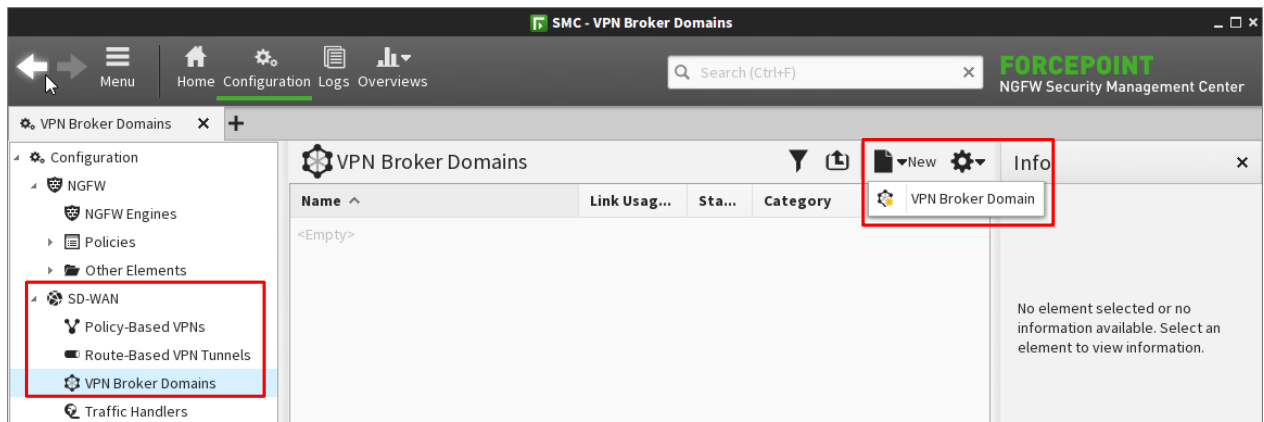
- 1) Open the Management Client.



- 2) Select  **Configuration**, then browse to **SD-WAN**.
- 3) Browse to **VPN Broker Domains**.
- 4) Select  **New** > **VPN Broker Domain**.

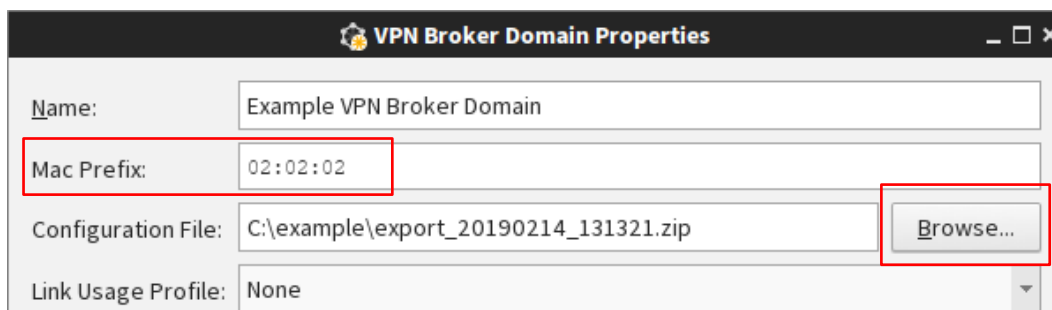

- 5) Configure the settings.
  - a) (Optional) Enter a name for the element.  
If you do not enter a name, the name is automatically generated based on the name of the configuration file.

- b) In the **Mac Prefix** field, enter the first three octets of the MAC address that is used by all members of the VPN Broker domain.  
This MAC address prefix must be the same as the MAC address prefix that is used in the VPN Broker Domain element that you created in the NGFW Manager.
- c) Next to the **Configuration File** field, click **Browse**, then select the configuration file that you exported from the NGFW Manager.
- d) Click **OK**.

VPN Broker Domain properties	
Option	Definition
<b>Name</b> (Optional)	The name of the element.
<b>Mac Prefix</b>	Enter the first three octets of the MAC address that is used by all members of the VPN Broker domain. This MAC address prefix must be the same as the MAC address prefix that is used in the VPN Broker Domain element that you created in the NGFW Manager.
<b>Configuration File</b>	Click <b>Browse</b> to select the configuration file that you exported from the NGFW Manager.
<b>Link Usage Profile</b> (Optional)	To use dynamic link selection for Multi-Link VPNs, select a Link Usage Profile element.  When you select a Link Usage Profile element in the properties of a policy-based VPN, route-based VPN tunnel group, or a VPN broker domain, the settings defined in the Link Usage Profile element are applied to all tunnels in the VPN according to their link types.

## Next steps

Add a VPN Broker Interface to the NGFW Engine.

# Add a VPN Broker Interface to the NGFW Engine

You must add a VPN Broker Interface to each NGFW Engine that is used as a VPN Broker member so that the VPN Broker can communicate with the members of a VPN Broker domain.

**Steps** ⓘ For more details about the product and how to configure features, click **Help** or press **F1**.

- 1) In the Management Client, select ⚙️ **Configuration**.

- 2) Right-click an NGFW Engine, then select **Edit <element type>**.

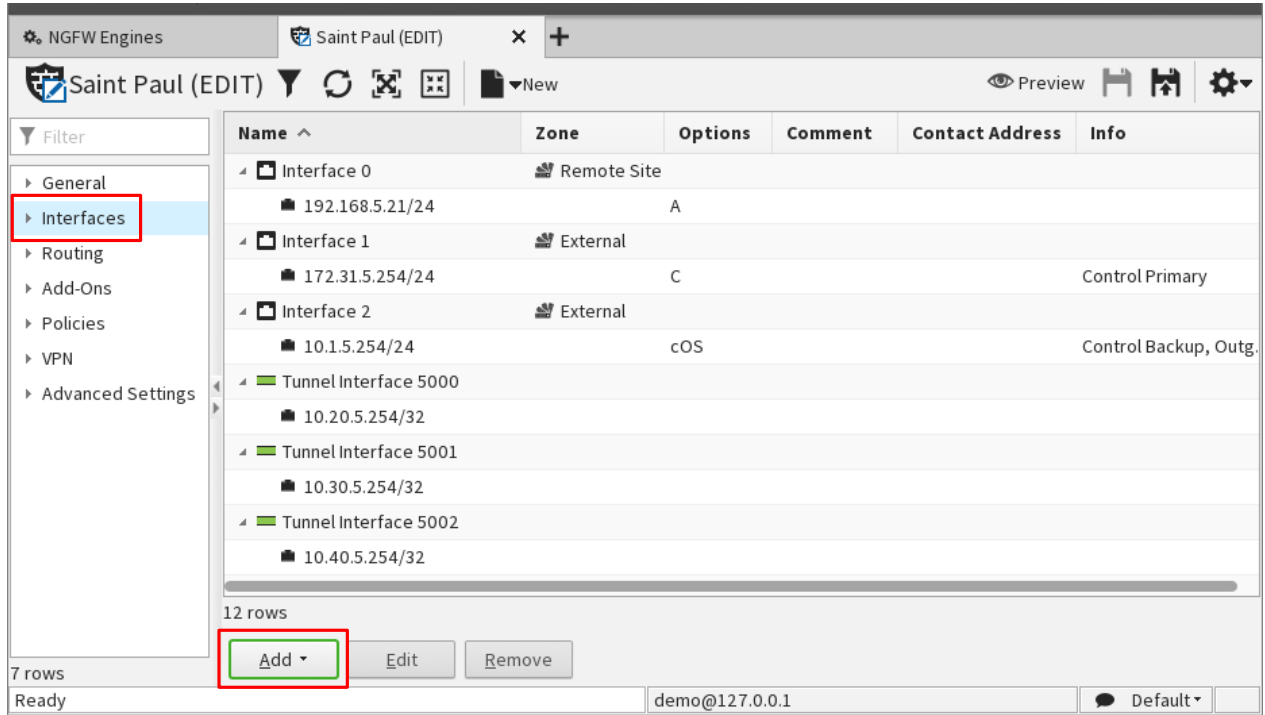

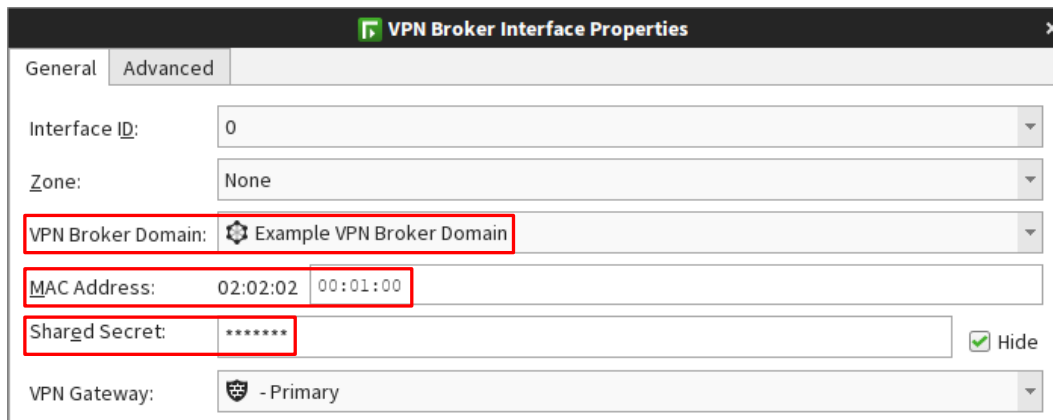

- 3) Browse to **Interfaces**.
- 4) Click **Add > VPN Broker Interface**.
- 5) Configure the settings.





- a) From the **VPN Broker Domain** drop-down list, select the VPN Broker Domain element that you created.
- b) In the **MAC Address** field, enter the last three octets of the MAC address for the VPN Broker member. This MAC address must be the same as the MAC address used in the corresponding VPN Broker Member element that you created in the NGFW Manager.
- c) In the **Shared Secret** field, enter the same password that you entered for the VPN Broker Member element in the NGFW Manager.



- d) Click **OK**.
- 6) Right-click the VPN Broker Interface, then select **New > IPv4 Address** or **New > IPv6 Address**.
- 7) Enter the IP address used in the corresponding VPN Broker Member element, then click **OK**.
- 8) Click  **Save and Refresh**, then click **OK** to transfer the changes to the NGFW Engine.

VPN Broker Interface properties	
Option	Definition
<b>General tab</b>	
<b>Interface ID</b>	<p>The ID number that identifies the VPN Broker Interface.</p> <p>The VPN Broker Interface is a virtual interface that is used only for the VPN Broker. The interface ID of the VPN Broker Interface can be the same as the interface ID of a physical interface on the same NGFW Engine.</p>
<b>Zone (Optional)</b>	Select the network zone to which the interface belongs. Click <b>Select</b> to select an element, or click <b>New</b> to create an element.
<b>VPN Broker Domain</b>	Select the VPN Broker Domain element that you created.
<b>MAC Address</b>	<div style="border: 1px solid #ccc; background-color: #f9f9f9; padding: 5px; margin-bottom: 10px;"> <p> <b>Note</b></p> <p>The MAC address prefix for the VPN Broker Domain is automatically added based on the VPN Broker Domain element.</p> </div> <p>Enter the last three octets of the MAC address for the VPN Broker member. This MAC address must be the same as the MAC address used in the corresponding VPN Broker Member element that you created in the NGFW Manager.</p>
<b>Shared Secret</b>	<p>Enter the password. The password must be the same as the shared secret that you entered for the VPN Broker Member element in the NGFW Manager.</p> <p>By default, passwords and keys are not shown in plain text. To show the password or key, deselect the <b>Hide</b> option.</p>
<b>VPN Gateway</b>	Select the local VPN gateway.
<b>Retrieve Routes from VPN Broker</b>	When selected, the routing table is updated with routes that are retrieved by the VPN Broker.
<b>Adjust Antispoofing according to retrieved routes</b>	When selected, antispoofing rules are automatically adjusted based on the routes that are retrieved by the VPN Broker.
<b>QoS Mode (Optional)</b>	<p>Defines how QoS is applied to the link on this interface.</p> <p>If <b>Full QoS</b> or <b>DSCP Handling and Throttling</b> is selected, a QoS policy must also be selected. If <b>Full QoS</b> is selected, the throughput must also be defined.</p> <p>If the interface is a Physical Interface, the same QoS mode is automatically applied to any VLANs created under it.</p>

Option	Definition
<b>QoS Policy</b>	<p><i>(When QoS Mode is Full QoS or DSCP Handling and Throttling)</i></p> <p>The QoS policy for the link on this interface.</p> <p>If the interface is a Physical Interface, the same QoS policy is automatically selected for any VLANs created under it.</p> <div data-bbox="451 373 506 428" style="float: left; margin-right: 10px;">  </div> <div data-bbox="537 373 1468 531" style="border: 1px solid #ccc; padding: 5px;"> <p><b>Note</b></p> <p>If a Virtual Resource has a throughput limit defined, the interfaces on the Virtual NGFW Engine that use a QoS policy all use the same policy. The policy used in the first interface is used for all the interfaces.</p> </div>
<b>Interface Throughput Limit</b>	<p><i>(When QoS Mode is Full QoS)</i></p> <p>Enter the throughput for the link on this interface as megabits per second.</p> <p>If the interface is a Physical Interface, the same throughput is automatically applied to any VLANs created under it.</p> <p>The throughput is for uplink speed (outgoing traffic) and typically must correspond to the speed of an Internet link (such as an ADSL line), or the combined speeds of several such links when connected to a single interface.</p> <div data-bbox="451 842 506 896" style="float: left; margin-right: 10px;">  </div> <div data-bbox="537 842 1468 1031" style="border: 1px solid #ccc; padding: 5px;"> <p><b>CAUTION</b></p> <p>Make sure that you set the interface speed correctly. When the bandwidth is set, the NGFW Engine always scales the total amount of traffic on this interface to the bandwidth you defined. This scaling happens even if there are no bandwidth limits or guarantees defined for any traffic.</p> </div> <div data-bbox="451 1066 506 1121" style="float: left; margin-right: 10px;">  </div> <div data-bbox="537 1066 1468 1255" style="border: 1px solid #ccc; padding: 5px;"> <p><b>CAUTION</b></p> <p>The throughput for a Physical Interface for a Virtual NGFW Engine must not be higher than the throughput for the Master NGFW Engine interface that hosts the Virtual NGFW Engine. Contact the administrator of the Master NGFW Engine before changing this setting.</p> </div>
<b>MTU</b> (Optional)	<p>The maximum transmission unit (MTU) size on the connected link. Either enter a value between 400–65535 or select a common MTU value from the list.</p> <p>If the interface is a Physical Interface, the same MTU is automatically applied to any VLANs created under it.</p> <p>The default value (also the maximum standard MTU in Ethernet) is 1500. Do not set a value larger than the standard MTU, unless you know that all devices along the communication path support it.</p> <p>To set the MTU for a Virtual NGFW Engine, you must configure the MTU for the interface on the Master NGFW Engine that hosts the Virtual NGFW Engine, then refresh the policy on the Master NGFW Engine and the Virtual NGFW Engine.</p>

## Next steps

Check the status of the VPN Broker.

# Check the status of the VPN Broker

To make sure that the components in the VPN Broker configuration are working correctly, check the status of the VPN Broker in the Management Client component of the SMC or on the command line of the NGFW Engine.

For more information about the monitoring features in the Management Client, see the *Forcepoint Next Generation Firewall Product Guide*.

## Steps

1) Check the status in one or more of the following ways:

- In the Home view of the Management Client, select an NGFW Engine to check the status of the connection between the NGFW Engine and the VPN Broker gateway. The **Status** tab of the **Info** pane shows the status.

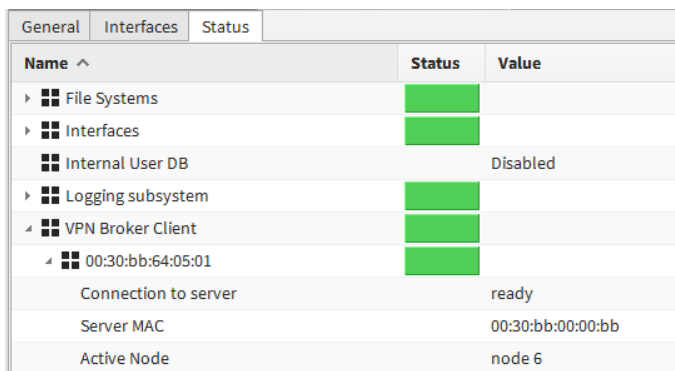

### Note

This status information is not available for Virtual NGFW Engines.

- In the Logs view of the Management Client, use the VPN Broker facility in a filter to show logs related to the VPN Broker.

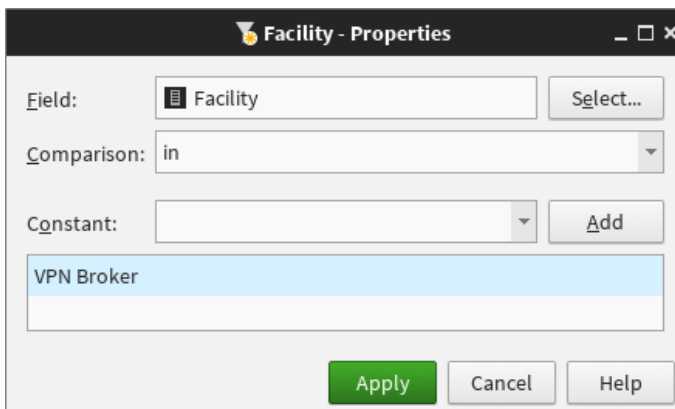

The following situations appear in log entries related to the VPN Broker:

Situation	Description
VPN-Broker_Client-Request	A VPN Broker member sent an information request to a VPN Broker gateway.
VPN-Broker_Connection_Error	The connection with the VPN Broker gateway has not been established.
VPN-Broker_Connection_Established	The connection with the VPN Broker gateway has been established.

- When VPN tunnels have been established between VPN Broker members, check the status of the tunnels in the SD-WAN dashboard in the Home view of the Management Client.
- On the command line of an NGFW Engine, enter the following command:

```
sg-brokerctl -s
```

On an NGFW Engine that acts as a VPN Broker gateway, the command shows a summary of the status of the connections between the VPN Broker members and the VPN Broker gateway. In a high availability environment, you can see if the VPN Broker gateways can be contacted. The age shown in the output should be 5 seconds or less. To check that the members have been synchronized correctly, you can enter `sg-brokerctl info` to check that the hash for `primary_member_hash` and `member_hash` match.

On an NGFW Engine that acts as a VPN Broker member, the command shows which other VPN Broker members the NGFW Engine can connect to, and shows the status of the connection between the NGFW Engine and the VPN Broker gateway.

## Result

You have now finished configuring the VPN Broker.

## Chapter 3

# Configuring VPN Broker high availability

### Contents

- [Getting started with VPN Broker high availability](#) on page 45
- [VPN Broker high availability configuration overview](#) on page 49
- [Start the NGFW Manager](#) on page 50
- [Select the mode in the NGFW Manager](#) on page 51
- [Configure an interface for members of the VPN Broker domain](#) on page 52
- [Create elements for the VPN Broker high availability configuration in the NGFW Manager](#) on page 55
- [Export a VPN Broker Domain element to a file for high availability](#) on page 65
- [Enable the VPN configuration in each NGFW Manager](#) on page 66
- [Create elements for the VPN Broker high availability configuration in the SMC](#) on page 67
- [Check the status of the VPN Broker](#) on page 73

When you configure high availability for the VPN Broker, there are multiple VPN Broker gateways in the same VPN Broker domain. All VPN Broker members can connect to any VPN Broker gateway in the VPN Broker domain.



#### Note

This document describes the currently supported features and options. Some features and options that are not yet supported might appear in the user interface.

## Getting started with VPN Broker high availability

The VPN Broker high availability environment consists of a VPN Broker domain, two or more VPN Broker gateways, and several VPN Broker members.

- **VPN Broker domain** — The VPN Broker domain is a virtual network that contains the VPN Broker gateways and the VPN Broker members.
- **VPN Broker gateways** — Each VPN Broker gateway is configured on a single pre-installed Forcepoint NGFW appliance that is dedicated for use only with the VPN Broker. When configuring the gateways in different instances of the NGFW Manager, set one as the primary gateway, and consider that NGFW Manager as the primary NGFW Manager. Changes that you make to the list of VPN Broker members in the primary NGFW Manager are automatically synchronized to other gateways.
- **VPN Broker member** — Each VPN Broker member is an NGFW Engine in the Firewall/VPN role (Single Firewall or Firewall Cluster). All VPN Broker members in the domain can connect to any VPN Broker gateway in the VPN Broker domain. When you use Master NGFW Engines and Virtual NGFW Engines, the same Master NGFW Engine can host VPN Broker members that belong to more than one VPN Broker domain.

VPN tunnels can be created between VPN Broker members that are controlled by different Management Servers. The members do not need to be in the same administrative Domain in the Forcepoint NGFW Security Management Center (SMC).

The following is an example environment for a VPN Broker high availability configuration. In this scenario, two VPN Broker gateways are configured in the same VPN Broker domain.

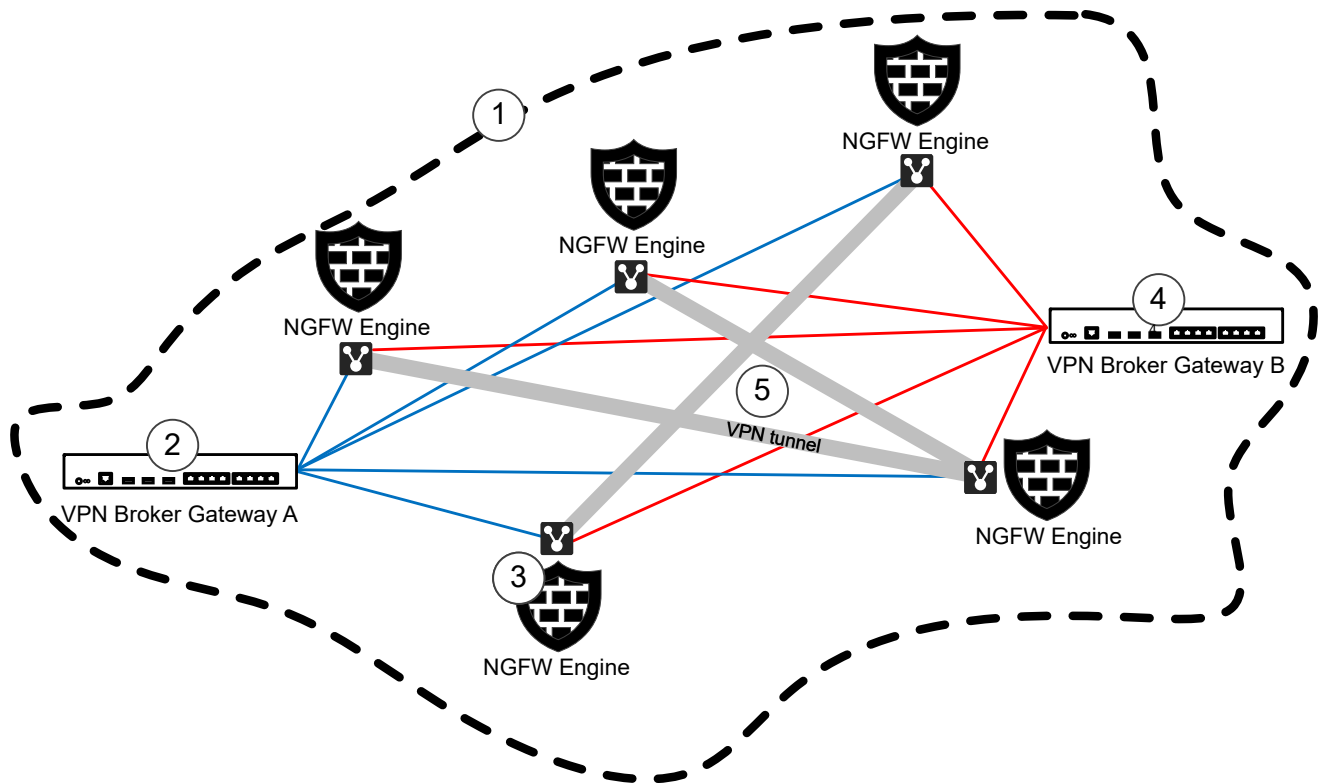

- 1** All VPN Broker members in the domain can connect to any VPN Broker gateway in the VPN Broker domain.
- 2** VPN Broker Gateway A  
Communication between VPN Broker gateways in the domain is authenticated using a shared secret. This gateway has been configured in the primary NGFW Manager. Changes that you make to the list of VPN Broker members in the primary NGFW Manager are automatically synchronized to other gateways.
- 3** VPN Broker member
- 4** VPN Broker Gateway B
- 5** VPN tunnels are created and removed as needed between the VPN Broker members. The tunnels are negotiated using RSA authentication.

Access rules that allow communication between the VPN Broker gateway and the members are automatically created. The communication between VPN Broker members and the VPN Broker gateway is authenticated using a shared secret.

The members communicate with the VPN Broker gateways using a VPN Broker Interface that you must configure on each NGFW Engine. The traffic that goes into the VPN also passes through this interface.

# VPN Broker gateway element types for VPN Broker high availability

In a VPN Broker high availability configuration, both VPN Broker Gateway and External VPN Broker Gateway elements are used.

- A VPN Broker Gateway element represents the local VPN Broker gateway in the NGFW Manager that manages it.
- An External VPN Broker Gateway element represents a remote VPN Broker gateway that is managed by a different NGFW Manager.

The same VPN Broker gateway is both a local VPN Broker gateway in its own configuration, and a remote VPN Broker gateway in the configurations of other VPN Broker gateways.

For example, VPN Broker Gateway A is managed by NGFW Manager A, and VPN Broker Gateway B is managed by NGFW Manager B. This table shows the element types that represent the VPN Broker gateways in each NGFW Manager.

## VPN Broker gateway element types

NGFW Manager	VPN Broker Gateway A	VPN Broker Gateway B
A	VPN Broker Gateway	External VPN Broker Gateway
B	External VPN Broker Gateway	VPN Broker Gateway

# How the VPN Broker Domain works in a high availability environment

The VPN Broker domain is a virtual network that contains the VPN Broker gateway and the VPN Broker members.

The following is an example of IP addresses and MAC addresses in the VPN Broker Domain.

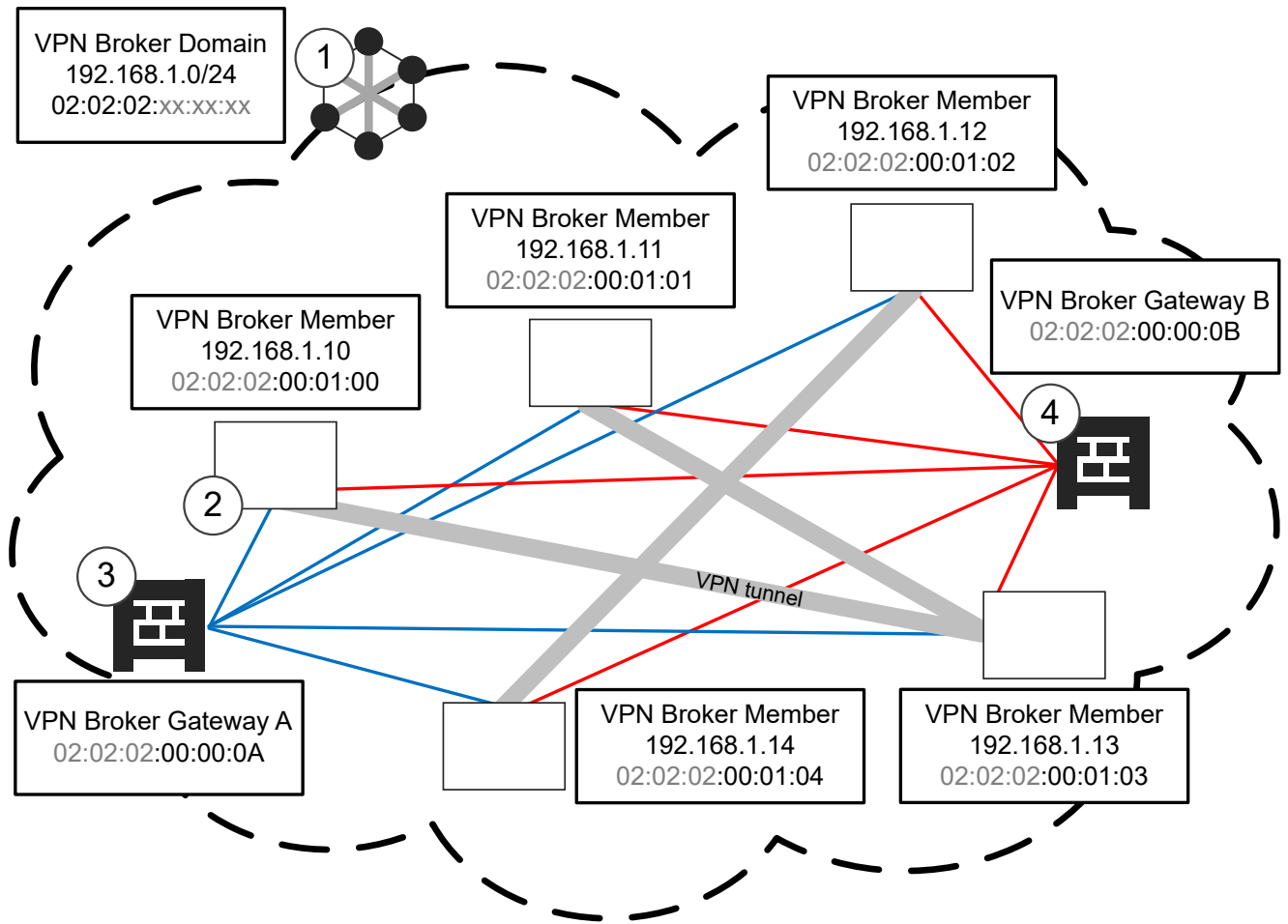

- 1 The VPN Broker Domain is a virtual network.  
The VPN Broker Domain is identified by a unique MAC address prefix. In this example, the MAC address prefix is 02:02:02.
- 2 Each VPN Broker Member has an IP address that is part of the virtual network defined in the VPN Broker Domain.  
Each VPN Broker Member is identified by a unique partial MAC address.
- 3 VPN Broker Gateway A is identified by a unique VPN Broker Gateway ID number. In this example, the VPN Broker Gateway ID is 10.  
This gateway has been configured in the primary NGFW Manager. Changes that you make to the list of VPN Broker members in the primary NGFW Manager are automatically synchronized to other gateways.
- 4 The VPN Broker Gateway B is identified by a unique VPN Broker Gateway ID number. In this example, the VPN Broker Gateway ID is 11.

The MAC address prefix of the VPN Broker Domain is combined with the partial MAC address of each VPN Broker Member to form a complete MAC address for each VPN Broker Member.

**Example of how VPN Broker Member MAC addresses are formed**

MAC address prefix of the VPN Broker Domain	Partial MAC address of the VPN Broker Member	Complete MAC address of the VPN Broker Member
02:02:02	00:01:00	02:02:02:00:01:00
	00:01:01	02:02:02:00:01:01



MAC address prefix of the VPN Broker Domain	Partial MAC address of the VPN Broker Member	Complete MAC address of the VPN Broker Member
	00:01:02	02:02:02:00:01:02
	00:01:03	02:02:02:00:01:03
	00:01:04	02:02:02:00:01:04

The MAC address prefix of the VPN Broker Domain is combined with the VPN Broker Gateway ID number to form a complete MAC address for each VPN Broker Gateway.

In this example, the VPN Broker Gateway ID number for VPN Broker Gateway A is 10, and the VPN Broker Gateway ID number for VPN Broker Gateway B is 11. In the NGFW Manager, you enter the VPN Broker Gateway ID as a decimal number. However, the ID is converted internally to a hexadecimal number. For example, an ID of 10 is converted to 0A in the MAC address of the VPN Broker Gateway. An ID of 11 is converted to 0B in the MAC address of the VPN Broker Gateway.

#### How VPN Broker Gateway MAC addresses are formed

MAC address prefix of the VPN Broker Domain	VPN Broker Gateway ID	Complete MAC address of the VPN Broker Gateway
02:02:02	10	02:02:02:00:00:0A
	11	02:02:02:00:00:0B

# VPN Broker high availability configuration overview

The configuration consists of these high-level steps.

## Steps in the NGFW Manager

- 1) Start the NGFW Manager, then select VPN Broker Management mode.
- 2) In each NGFW Manager, configure the interface to which members of the VPN Broker domain can connect.
- 3) In each NGFW Manager, create the required elements in the following order:
  - a) One VPN Broker Gateway element to represent the local VPN Broker gateway.
  - b) External VPN Broker Gateway elements to represent all remote VPN Broker gateways.
  - c) One VPN Broker Domain element to which all VPN Broker gateways and external VPN Broker gateways belong.

When creating one of the VPN Broker Domain elements, you must set it to be the primary. Consider the NGFW Manager that you create the primary VPN Broker Domain element in as the primary NGFW Manager.

- 4) In the primary NGFW Manager, add VPN Broker Member elements.  
Changes that you make to the list of VPN Broker members in the primary NGFW Manager are automatically synchronized to other gateways.
- 5) In the primary NGFW Manager, export the VPN Broker Domain element to a file.
- 6) In each NGFW Manager, enable the VPN configuration in the properties of the NGFW Engine.

## Steps in the Management Client component of the SMC

---

- 1) Create the required elements in the following order:
  - a) Create one VPN Broker Domain element.  
Import the VPN Broker Domain configuration file into the configuration of the VPN Broker Domain element.
  - b) Add a VPN Broker Interface to all NGFW Engines that are used as VPN Broker members.
- 2) Refresh the firewall policy.



### Note

VPN Broker provides connectivity between networks of the VPN Broker members. You must add Access rules to the policy of each NGFW Engine to allow specific types of traffic to and from these networks.

Begin the configuration by starting the NGFW Manager.

## Start the NGFW Manager

---

The NGFW Configuration Wizard allows you to configure settings for the Forcepoint NGFW appliance. Start the NGFW Manager from the web browser version of the NGFW Configuration Wizard.

### Steps

- 1) Connect the NGFW appliance to a laptop or other client device.  
Connect an Ethernet cable from the client device to physical port eth0\_1 on the NGFW appliance. If the NGFW appliance does not have a port eth0\_1, use port eth1\_0. If using non-modular interfaces, use port eth1.
- 2) Connect the other network cables to the Forcepoint NGFW appliance.
- 3) Turn on the Forcepoint NGFW appliance.
- 4) To start the web browser version of the NGFW Configuration Wizard, open a web browser on the client device, then connect to <https://169.254.169.169>.  
It might take some time for the web page to load.

- 5) When the NGFW Configuration Wizard offers a web browser client certificate, accept the certificate.
- 6) On the Welcome page of the NGFW Configuration Wizard, click **Start**.
- 7) Select **I Agree to the Terms and Conditions**, then click **Next**.
- 8) Enter and confirm the password for the root account, then click **Next**.

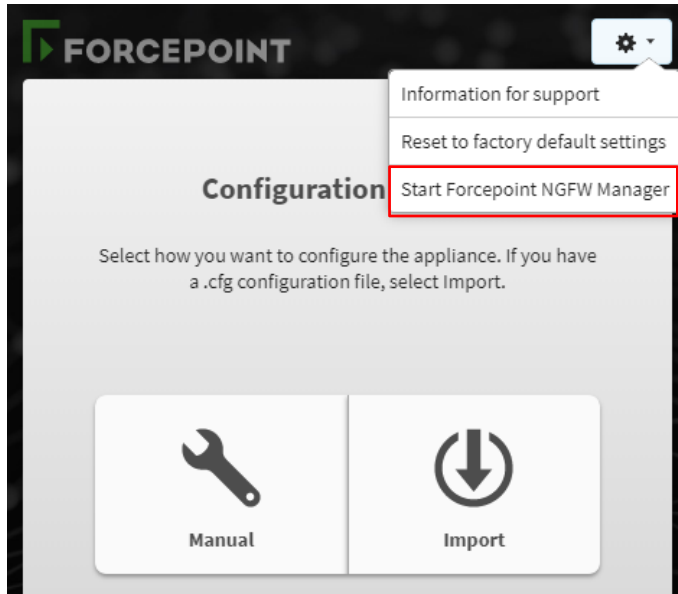

- 9) Click **⚙** > **Start Forcepoint NGFW Manager** to restart the appliance.
- 10) After the NGFW appliance has restarted, refresh the web browser to start the NGFW Manager.
- 11) Enter `root` as the user name, enter the password for the root account, then click **Log In**.

## Next steps

Continue by selecting the mode in the NGFW Manager.

# Select the mode in the NGFW Manager

Modes in the NGFW Manager allow you to either configure the VPN Broker or locally manage a single NGFW Engine.

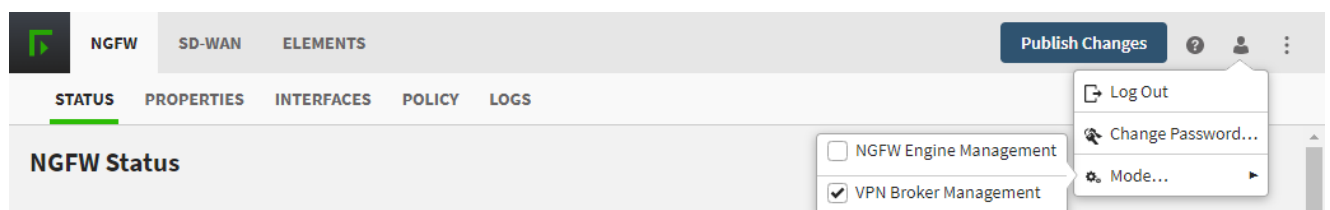

## Steps

- 1) Select **User** > **Mode**, then select the mode.
  - **VPN Broker Management** — Allows you to configure the VPN Broker. In this mode, elements and options related to the VPN Broker are shown in addition to elements and options related to the management of the NGFW Engine.
  - **NGFW Engine Management** — Allows you to locally manage a single NGFW Engine. In this mode, elements and options related to the VPN Broker are not shown.

## Next steps

Continue the configuration in one of the following ways:

- If you are configuring the VPN Broker, configure an interface for members of the VPN Broker domain.
- If you are locally managing a single NGFW Engine, create elements to use for NGFW Engine configuration.

# Configure an interface for members of the VPN Broker domain

Interfaces for each Ethernet port on the NGFW appliance are automatically included in the interface table. In each NGFW Manager, you must add an IP address for the interface to which members of the VPN Broker domain can connect.

### Before you begin

Start the NGFW Manager, then select VPN Broker Management mode.

## Steps

- 1) Browse to **NGFW > Interfaces**.

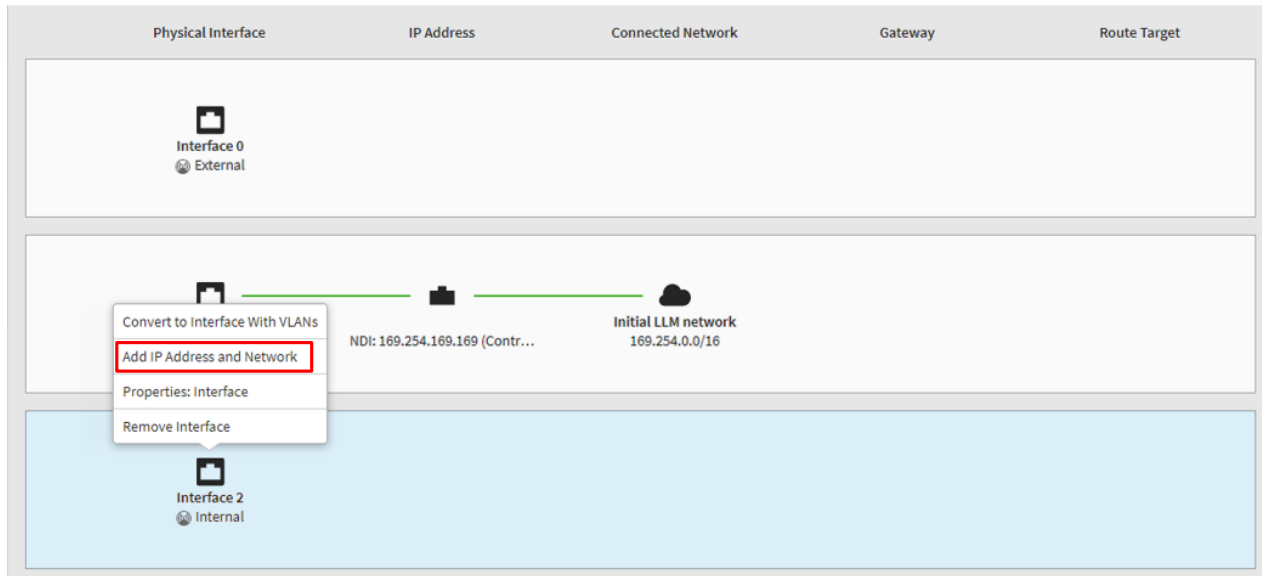

- 2) In the interface table below the appliance image, click an interface, then select **Add IP Address and Network**.
- 3) Enter the IP address and netmask to which members of the VPN Broker domain can connect in CIDR notation, then click **Save**.

Fields marked with an asterisk \* in the user interface are mandatory.

Interfaces & Routing page	
Option	Definition
New	<p>Adds an interface to the interfaces table. If you change the number of Ethernet ports on the NGFW appliance, such as by replacing a 4-port interface module with an 8-port interface module, you must add interfaces to represent the new Ethernet ports.</p> <ul style="list-style-type: none"> <li>■ <b>Interface</b> — Adds a physical interface. Opens the <b>New Interface</b> dialog.</li> <li>■ <b>Interface with VLANs</b> — Adds a physical interface with a placeholder for adding VLAN interfaces later. Opens the <b>New Interface With VLANs</b> dialog.</li> <li>■ <b>Tunnel Interface</b> — This option is not yet supported.</li> </ul>
Appliance image	Shows the ports on the NGFW appliance for which you can configure interfaces. When you select an interface in the interface table, the corresponding port is highlighted in the image.
Interface table	Allows you to configure the IP addresses, networks, and routing for each interface.

Option	Definition
<b>Physical Interface</b>	<p><i>(When interface type is Physical Interface)</i></p> <p>Shows the interface ID of the physical interfaces. The following actions are available when you click the interface:</p> <ul style="list-style-type: none"> <li>■ <b>Add IP Address and Network</b> — Adds an IP address and a Network element to the interface. Opens the <b>New IP Address and Netmask</b> dialog box.</li> <li>■ <b>Convert to Interface With VLANs</b> — Removes any IP addresses that have been specified and converts the interface to an interface with VLANs.</li> <li>■ <b>Properties: Interface</b> — Opens the interface properties.</li> <li>■ <b>Remove Interface</b> — Removes the interface from the configuration.</li> </ul>
<b>Physical Interface</b>	<p><i>(When interface type is Physical Interface with VLAN interfaces)</i></p> <p>Shows the interface ID of the physical interfaces and the VLAN interfaces under them. The following actions are available when you click the physical interface:</p> <ul style="list-style-type: none"> <li>■ <b>Add VLAN Interface</b> — Adds a VLAN interface.</li> <li>■ <b>Convert to Interface</b> — Converts the interface with VLANs to an interface. There can be a maximum of one VLAN Interface when you convert the interface.</li> <li>■ <b>Properties: Interface with VLANs</b> — Opens the interface properties.</li> <li>■ <b>Remove Interface</b> — Removes the interface from the configuration.</li> </ul> <p>The following actions are available when you click the VLAN interface:</p> <ul style="list-style-type: none"> <li>■ <b>Add IP Address and Network</b> — Adds an IP address and a Network element to the interface. Opens the <b>New IP Address and Netmask</b> dialog box.</li> <li>■ <b>Properties: VLAN Interface</b> — Opens the VLAN interface properties.</li> <li>■ <b>Remove VLAN Interface</b> — Removes the VLAN interface.</li> </ul>
<b>IP Address</b>	<p>Shows the IP address of the physical interface or VLAN interface. The following actions are available when you click the IP address:</p> <ul style="list-style-type: none"> <li>■ <b>Properties: Static Address</b> — Allows you to add a static IP address to the interface.</li> <li>■ <b>Remove IP Address and Network</b> — Removes the IP address from the interface configuration.</li> </ul>
<b>Connected Network</b>	<p>Shows the network range of the directly connected network. The following options are available when you click the network:</p> <ul style="list-style-type: none"> <li>■ <b>Add Gateway</b> — Allows you to add a route through a gateway device to a network that is not directly connected.</li> <li>■ <b>Properties: Network</b> — Opens the properties of the Network element.</li> </ul>
<b>Gateway</b>	<p>Shows the gateway device through which the NGFW Engine connects to a network that is not directly connected. The following actions are available when you click the gateway:</p> <ul style="list-style-type: none"> <li>■ <b>Add Route Target</b> — Allows you to specify the IP addresses that are reachable through the gateway device.</li> <li>■ <b>Properties: &lt;element type&gt;</b> — Opens the properties of the element that represents the gateway device.</li> <li>■ <b>Remove Gateway</b> — Removes the gateway device from the interface configuration. The element is not deleted.</li> </ul>

Option	Definition
<b>Route Target</b>	Shows the IP addresses that are reachable through the gateway device. The following options are available when you click the route target: <ul style="list-style-type: none"> <li>■ <b>Properties: &lt;element type&gt;</b> — Opens the properties of the element that represents the IP addresses.</li> <li>■ <b>Remove Route Target</b> — Removes the route target from the interface configuration. The element is not deleted.</li> </ul>

#### Interface properties

Option	Definition
<b>Interface ID</b>	<i>(When interface type is Physical Interface)</i> The Interface ID automatically maps to a physical network port on the appliance.
<b>VLAN ID</b>	<i>(When interface type is VLAN Interface)</i> Specifies the VLAN ID (1–4094). The VLAN IDs must be the same as the VLAN IDs that are used in the switch at the other end of the VLAN trunk. Each VLAN Interface is identified as Interface-ID.VLAN-ID, for example, 2.100 for Interface ID 2 and VLAN ID 100.
<b>Interface Options (Optional)</b>	Advanced options for interface configuration.
<b>MTU</b>	The maximum transmission unit (MTU) size on the connected link. Enter a value between 576–65000.
<b>Zone</b>	The network zone to which the interface belongs. By default, Interface 0 belongs to the external zone. All other interfaces belong to the internal zone.
<b>Antispoofing Elements</b>	This option is not yet supported.
<b>Route Replies Back</b>	This option is not yet supported.

## Next steps

Create elements for the VPN Broker configuration in the NGFW Manager.

# Create elements for the VPN Broker high availability configuration in the NGFW Manager

You must create the elements that represent the VPN Broker configuration in the NGFW Manager.

The following elements are used in the configuration:

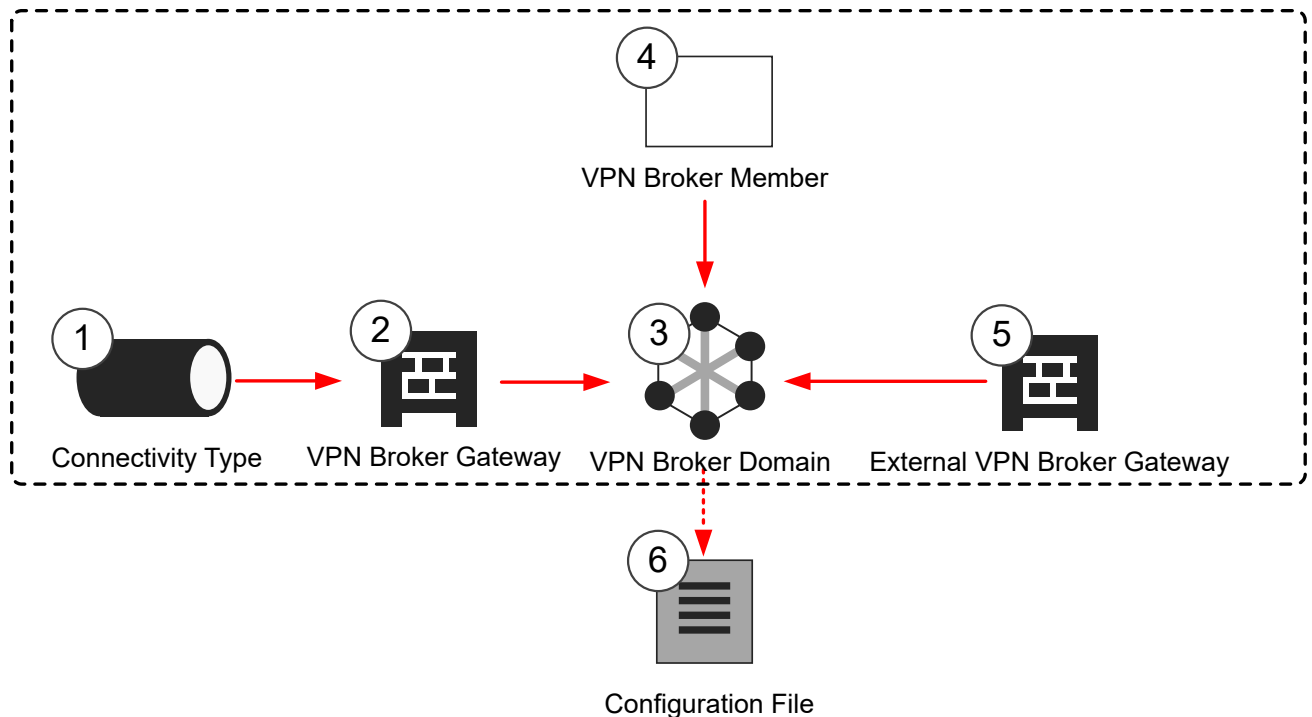

- 1 Connectivity Type elements define the connectivity group to which endpoints belong, and the mode used when an endpoint is part of a Multi-Link configuration.  
The default system Connectivity Type elements belong to connectivity group 1. If you need to use a different connectivity group, create a custom Connectivity Type element.
- 2 The VPN Broker Gateway element represents the local VPN Broker and contains information about the available endpoints.
- 3 The VPN Broker Domain is used to group all the VPN Broker members in a single domain.  
You must create an identical VPN Broker Domain element in each NGFW Manager.
- 4 Each VPN Broker Member element represents an NGFW Engine.
- 5 Each External VPN Broker Gateway element represents a remote VPN Broker.
- 6 The configuration file for one VPN Broker Domain is exported from the NGFW Manager.

## Next steps

Begin the configuration in one of the following ways:

- If you need a custom Connectivity Type element, create a Connectivity Type element.
- Otherwise, create a VPN Broker Gateway element to represent the local VPN Broker.

# Create Connectivity Type elements in the NGFW Manager

Connectivity Type elements define the connectivity group to which endpoints belong, and the mode used when an endpoint is part of a Multi-Link configuration. If the default Connectivity Type elements meet your needs, it is not necessary to create custom Connectivity Type elements.



The default system Connectivity Type elements belong to connectivity group 1. If you need to use a different connectivity group, create a custom Connectivity Type element.

## Steps

- 1) Browse to **SD-WAN > Other SD-WAN Elements > Connectivity Type**.

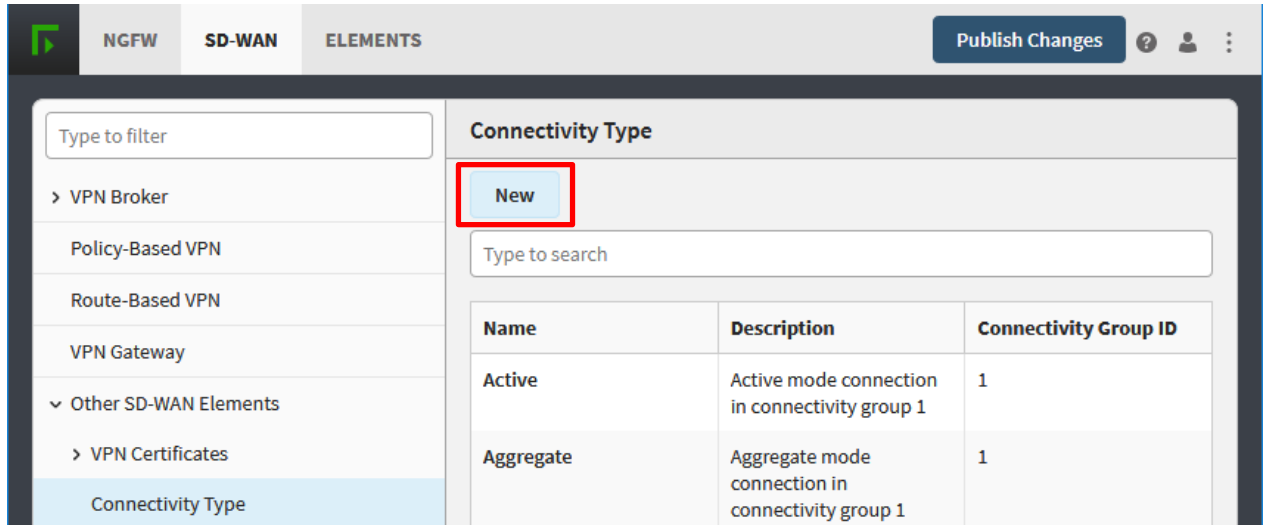

- 2) Click **New**.
- 3) Configure the settings, then click **Save**.

Fields marked with an asterisk \* in the user interface are mandatory.

Connectivity Type Properties	
Option	Definition
<b>Mode</b>	Select one of the options to define how the endpoint is used in a Multi-Link configuration: <ul style="list-style-type: none"> <li>■ <b>Active</b> — The link is always used. If there are multiple links in Active mode between the Gateways, the VPN traffic is load-balanced between the links based on the load of the links. VPN traffic is directed to the link that has the lowest load.</li> <li>■ <b>Aggregate</b> — The link is always used, and each VPN connection is load-balanced in round-robin fashion between all the links that are in Aggregate mode. For example, if there are two links in Aggregate mode, a new VPN connection is directed to both links.</li> <li>■ <b>Standby</b> — The link is used only when all Active or Aggregate mode links are unusable.</li> </ul>
<b>Connectivity Group ID</b>	Enter or select the number of the connectivity group to which the endpoint belongs. Tunnels are created only between endpoints that belong to the same connectivity group.
<b>Link Type</b>	This option is not yet supported.

## Next steps

Create a VPN Broker Gateway element.

# Create a local VPN Broker Gateway element for VPN Broker high availability

In each NGFW Manager, create one VPN Broker Gateway element to represent the local VPN Broker gateway.

## Steps

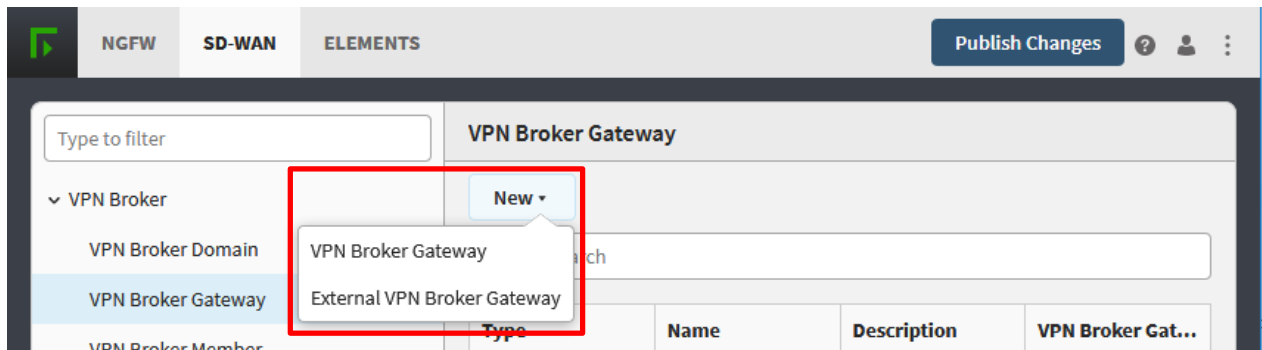

- 1) Browse to **SD-WAN > VPN Broker > VPN Broker Gateway**.



- 2) Click **New > VPN Broker Gateway**.
- 3) Add a row in one of the following ways:
  - Click **...** > **Add VPN Endpoint** to add the first row.
  - Click **...** > **New > VPN Broker Endpoint Before** to add a row above the selected row.
  - Click **...** > **New > VPN Broker Endpoint After** to add a row below the selected row.
- 4) Configure the settings, then click **Save**.

Fields marked with an asterisk \* in the user interface are mandatory.

VPN Broker Gateway properties	
Option	Definition
<b>Endpoints table</b>	
To edit the contents of a cell, click the cell. Click <b>...</b> > <b>New &gt; VPN Broker Endpoint Before</b> or <b>...</b> > <b>New &gt; VPN Broker Endpoint After</b> to add a row.	
<b>Info</b>	You can enter a name and a comment for the endpoint.
<b>Endpoint Address</b>	Select <b>NGFW Engine IP Address</b> , select <b>Static Address</b> , then select an element from the <b>Static IP Address</b> folder that represents the interface to use for the endpoint. Type part of the name of an element or browse through the drop-down list to select an element.

Option	Definition
<b>Endpoint Class</b>	<p>Select a default system Connectivity Type element that has the appropriate mode selected. Type part of the name of an element or browse through the drop-down list to select an element.</p> <p>The following system Connectivity Type elements are available:</p> <ul style="list-style-type: none"> <li>■ <b>Active</b> — The link is always used. If there are multiple links in Active mode between the Gateways, the VPN traffic is load-balanced between the links based on the load of the links. VPN traffic is directed to the link that has the lowest load.</li> <li>■ <b>Aggregate</b> — The link is always used, and each VPN connection is load-balanced in round-robin fashion between all the links that are in Aggregate mode. For example, if there are two links in Aggregate mode, a new VPN connection is directed to both links.</li> <li>■ <b>Standby</b> — The link is used only when all Active or Aggregate mode links are unusable.</li> </ul>
<b>Enabled</b>	When selected, the endpoint is enabled. You can temporarily disable the endpoint without deleting it.
<b>Used for Client Gateways</b>	When <b>Yes</b> is selected, VPN Broker members can communicate using the endpoint. If there is an intermediate NAT device between this VPN Broker and VPN Broker members, add a contact address.
<b>Used for Broker Servers</b>	When <b>Yes</b> is selected, other VPN Broker gateways can communicate using the endpoint. If there is an intermediate NAT device between this VPN Broker and other VPN Broker gateways, add a contact address.
<b>VPN Broker Gateway ID</b>	<p>Enter a unique ID number for the VPN Broker Gateway as an integer. The allowed range is 1–255.</p> <div style="border: 1px solid #ccc; background-color: #f9f9f9; padding: 10px; margin: 10px 0;"> <p> <b>Note</b></p> <p>In the NGFW Manager, you enter the VPN Broker Gateway ID as a decimal number. However, the ID is converted internally to a hexadecimal number. For example, an ID of 10 is converted to 0A in the MAC address of the VPN Broker Gateway. The allowed range in hexadecimal numbers is 1–FF.</p> </div> <p>When a log entry is generated, the SMC uses this value to identify the VPN Broker that generated the log entry.</p> <div style="border: 1px solid #ccc; background-color: #f9f9f9; padding: 10px; margin: 10px 0;"> <p> <b>Tip</b></p> <p>We recommend that you make a note of the VPN Broker Gateway ID for each VPN Broker Gateway.</p> </div>

## Next steps

Create External VPN Broker Gateway elements to represent all remote VPN Broker gateways.

# Create External VPN Broker Gateway elements for VPN Broker high availability

External VPN Broker Gateways are remote VPN Broker gateways that are managed by a different NGFW Manager. You must create one External VPN Broker Gateway element to represent each remote VPN Broker gateway in each NGFW Manager.

## Steps

- 1) Browse to **SD-WAN > VPN Broker > VPN Broker Gateway**.

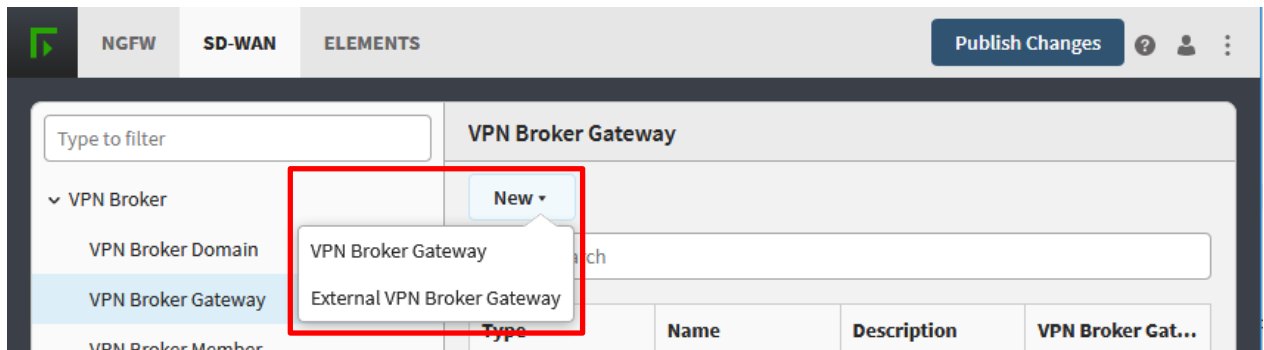

- 2) Click **New > External VPN Broker Gateway**.
- 3) Add a row in one of the following ways:
  - Click **...** > **Add VPN Endpoint** to add the first row.
  - Click **...** > **New > VPN Broker Endpoint Before** to add a row above the selected row.
  - Click **...** > **New > VPN Broker Endpoint After** to add a row below the selected row.
- 4) Configure the settings, then click **Save**.

Fields marked with an asterisk \* in the user interface are mandatory.

External VPN Broker Gateway properties	
Option	Definition
<b>Endpoints table</b> To edit the contents of a cell, click the cell. Click <b>...</b> > <b>New &gt; VPN Broker Endpoint Before</b> or <b>...</b> > <b>New &gt; VPN Broker Endpoint After</b> to add a row.	
<b>Info</b>	You can enter a name and a comment for the endpoint.
<b>Endpoint Address</b>	Enter the IP address of the remote gateway.
<b>Endpoint Class</b>	Select a default system Connectivity Type element that has the appropriate mode selected. Type part of the name of an element or browse through the drop-down list to select an element. The following system Connectivity Type elements are available: <ul style="list-style-type: none"> <li>■ <b>Active</b> — The link is always used. If there are multiple links in Active mode between the Gateways, the VPN traffic is load-balanced between the links based on the load of the links. VPN traffic is directed to the link that has the lowest load.</li> <li>■ <b>Aggregate</b> — The link is always used, and each VPN connection is load-balanced in round-robin fashion between all the links that are in Aggregate mode. For example, if there are two links in Aggregate mode, a new VPN connection is directed to both links.</li> <li>■ <b>Standby</b> — The link is used only when all Active or Aggregate mode links are unusable.</li> </ul>
<b>Enabled</b>	When selected, the endpoint is enabled. You can temporarily disable the endpoint without deleting it.

Option	Definition
<b>Used for Client Gateways</b>	When <b>Yes</b> is selected, VPN Broker members can communicate using the endpoint. If there is an intermediate NAT device between this VPN Broker and VPN Broker members, add a contact address.
<b>Used for Broker Servers</b>	When <b>Yes</b> is selected, external VPN Broker gateways can communicate using the endpoint. If there is an intermediate NAT device between this VPN Broker and other VPN Broker gateways, add a contact address.
<b>Shared Secret</b>	<p>To specify the shared secret that VPN Broker Gateways use to authenticate each other in a high availability configuration, click <b>Shared Secret</b>, enter the shared secret, then click <b>Save</b>.</p> <div data-bbox="451 520 490 571"></div> <div data-bbox="548 527 591 556"><b>Tip</b></div> <div data-bbox="548 573 1175 602">We recommend that you make a note of the shared secret.</div> <div data-bbox="451 655 506 705"></div> <div data-bbox="548 663 609 693"><b>Note</b></div> <div data-bbox="548 709 1440 768">Enter the same shared secret in the properties of each VPN Broker Gateway in the same VPN Broker Domain.</div>
<b>VPN Broker Gateway ID</b>	<p>Enter a unique ID number for the VPN Broker Gateway as an integer. The allowed range is 1–255.</p> <div data-bbox="451 877 506 928"></div> <div data-bbox="548 888 609 917"><b>Note</b></div> <div data-bbox="548 932 1455 1050">In the NGFW Manager, you enter the VPN Broker Gateway ID as a decimal number. However, the ID is converted internally to a hexadecimal number. For example, an ID of 10 is converted to 0A in the MAC address of the VPN Broker Gateway. The allowed range in hexadecimal numbers is 1–FF.</div> <p>When a log entry is generated, the SMC uses this value to identify the VPN Broker that generated the log entry.</p> <div data-bbox="451 1176 490 1226"></div> <div data-bbox="548 1186 591 1215"><b>Tip</b></div> <div data-bbox="548 1230 1440 1289">We recommend that you make a note of the VPN Broker Gateway ID for each VPN Broker Gateway.</div>

## Next steps

Create identical VPN Broker Member elements in each NGFW Manager.

# Create VPN Broker Domain elements for VPN Broker high availability

The VPN Broker Domain element defines the virtual network that contains the local and remote VPN Broker gateways, and the VPN Broker domain members.

Create a VPN Broker Domain element in each NGFW Manager. When creating one of the VPN Broker Domain elements, you must set it to be the primary. Consider the NGFW Manager that you create the primary VPN Broker Domain element in as the primary NGFW Manager. Changes that you make to the list of VPN Broker members in the primary NGFW Manager are automatically synchronized to other gateways.

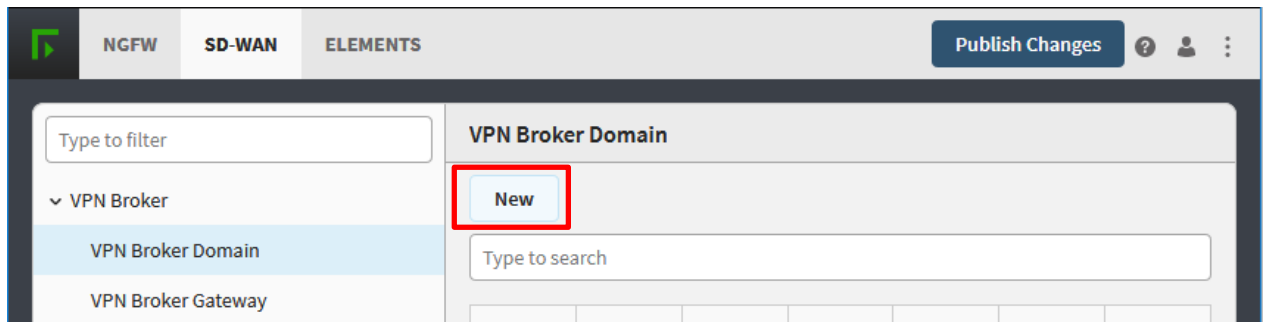

## Steps

- 1) Browse to **SD-WAN > VPN Broker > VPN Broker Domain**.



- 2) Click **New**.
- 3) Configure the settings, then click **Save**.

Fields marked with an asterisk \* in the user interface are mandatory.

VPN Broker Domain properties	
Option	Definition
<b>IPv4 Network or IPv6 Network</b>	<p>Enter the IP address and netmask of the virtual network that contains all of the members of the VPN Broker domain. You must enter an IPv4 network, an IPv6 network, or both.</p> <p> <b>Tip</b> We recommend that you make a note of the IP addresses for each VPN Broker Domain.</p>
<b>VPN Broker Gateway</b>	Select the local VPN Broker Gateway that belongs to the VPN Broker domain. Type part of the name of an element or browse through the drop-down list to select an element.
<b>External VPN Broker Gateways</b>	Select all External VPN Broker Gateways that belong to the VPN Broker domain. Type part of the name of an element or browse through the drop-down list to select an element.
<b>MAC Address Prefix</b>	<p>Enter a unique identifier for the VPN Broker Domain in MAC address format. The length must be three octets. The first octet must be even. The address must be a unique unicast MAC address.</p> <p> <b>Tip</b> We recommend that you make a note of the MAC Address Prefix for each VPN Broker Domain.</p>
<b>Primary VPN Broker Server</b>	In a high availability environment, one NGFW Manager must be set as the primary NGFW Manager for each VPN Broker Domain. When you make changes to the list of VPN Broker members in the primary NGFW Manager, the changes are synchronized to the other instances of the NGFW Manager. If this NGFW Manager is offline, you must manually promote another NGFW Manager to be the primary.
<b>Enabled</b>	When selected, the VPN Broker Domain element is enabled. You can temporarily disable the element without deleting it.

## Next steps

In each NGFW Manager, create one VPN Broker Gateway element to represent the local VPN Broker gateway.

# Create VPN Broker Members for VPN Broker high availability

Create VPN Broker Member elements to represent each NGFW Engine that is used in the VPN Broker configuration.

Changes that you make to the list of VPN Broker members in the primary NGFW Manager are automatically synchronized to other gateways.

## Steps

- 1) Browse to **SD-WAN > VPN Broker > VPN Broker Member**.

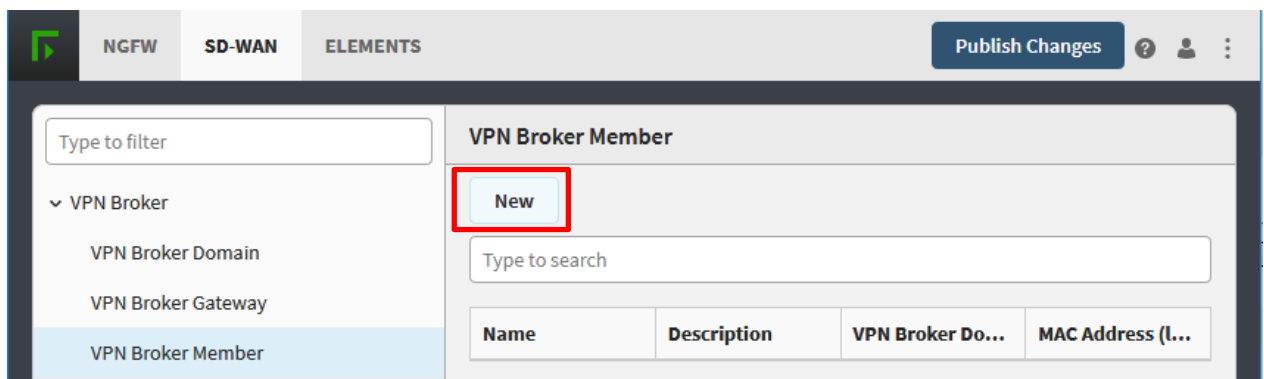

- 2) Click **New**.
- 3) Configure the settings, then click **Save**.

Fields marked with an asterisk \* in the user interface are mandatory.

VPN Broker Member properties	
Option	Definition
VPN Broker Domain	Select the VPN Broker Domain element that you created. Type part of the name of an element or browse through the drop-down list to select an element.

Option	Definition
<p><b>Mac Address (last three octets)</b></p>	<p>Enter a unique identifier for the VPN Broker Member as the last three octets of a MAC address. The allowed range is 00:01:00–ff:ff:ff. Each member in the domain must have a unique identifier. When adding a VPN Broker Interface to an NGFW Engine in the SMC, use the same value that is used in the corresponding VPN Broker Member element in the NGFW Manager.</p> <div data-bbox="451 359 506 411" style="float: left; margin-right: 10px;"></div> <div data-bbox="537 359 1468 485" style="background-color: #f0f0f0; padding: 5px;"> <p><b>Note</b></p> <p>The range 00:00:01– 00:00:FF is reserved for the VPN Broker Gateway element. You cannot use identifiers in this range for members in the domain.</p> </div> <div data-bbox="451 527 490 579" style="float: left; margin-right: 10px;"></div> <div data-bbox="537 527 1468 653" style="background-color: #f0f0f0; padding: 5px;"> <p><b>Tip</b></p> <p>We recommend that you make a note of the MAC addresses for each VPN Broker Member.</p> </div>
<p><b>Shared Secret</b></p>	<p>Click <b>Enter Shared Secret</b> to enter a password. Click <b>Change Shared Secret</b> to change a password that has already been set.</p> <p>When adding a VPN Broker Interface to an NGFW Engine in the SMC, use the same value that is used in the corresponding VPN Broker Member element in the NGFW Manager.</p> <div data-bbox="451 852 490 905" style="float: left; margin-right: 10px;"></div> <div data-bbox="537 852 1468 947" style="background-color: #f0f0f0; padding: 5px;"> <p><b>Tip</b></p> <p>We recommend that you make a note of the shared secret.</p> </div>
<p><b>IPv4 Address or IPv6 Address</b></p>	<p>Enter a member IP address that is part of the virtual network defined in the VPN Broker Domain element. You must enter an IPv4 address, an IPv6 address, or both.</p> <p>Use the same kind of IP address that the VPN Broker Domain uses. For example, if the VPN Broker Domain has only IPv4 addresses, enter an IPv4 address. You can enter both an IPv4 address and an IPv6 address if the VPN Broker Domain has both IPv4 addresses and IPv6 addresses.</p> <div data-bbox="451 1209 490 1262" style="float: left; margin-right: 10px;"></div> <div data-bbox="537 1209 1468 1335" style="background-color: #f0f0f0; padding: 5px;"> <p><b>Tip</b></p> <p>We recommend that you make a note of the IP addresses for each VPN Broker Member.</p> </div>
<p><b>Networks table</b></p> <p>To edit the contents of a cell, click the cell.</p> <p>Click <b>⋮</b> &gt; <b>Add</b> to add the first row.</p> <p>Click <b>⋮</b> &gt; <b>New</b> &gt; <b>Row Before</b> or <b>⋮</b> &gt; <b>New</b> &gt; <b>Row After</b> to add a row.</p>	
<p><b>Network</b></p>	<p>Select the networks that are reachable through the VPN Broker member. Type part of the name of an element or browse through the drop-down list to select an element.</p>



Option	Definition
<b>Mode</b>	<p>Select from the following options.</p> <ul style="list-style-type: none"> <li>■ <b>Reserved</b> — Network addresses are dedicated to the gateway and these addresses or a subnet of these addresses cannot be given to any other member of the VPN Broker domain. This is the recommended option.</li> <li>■ <b>Allowed</b> — Network addresses are allowed for the VPN gateway. However, the VPN Broker does not announce these as routes to other VPN gateways. Used for dynamic routing or the default VPN gateway.</li> <li>■ <b>Routed</b> — When selected, enter a value in the <b>Metric</b> field. The same network address that has a different route metric value can be given to another VPN gateway. The subnet of a specified network can be given to a specified VPN gateway.</li> </ul>

## Next steps

In the primary NGFW Manager, export the VPN Broker Domain element to a file.

# Export a VPN Broker Domain element to a file for high availability

In the primary NGFW Manager, export the VPN Broker Domain element to a file.

The configuration of the VPN Broker Domain element must contain information about all VPN Broker gateways and VPN Broker members in the same VPN Broker domain.

## Steps

- 1) Browse to **SD-WAN > VPN Broker > VPN Broker Domain**.

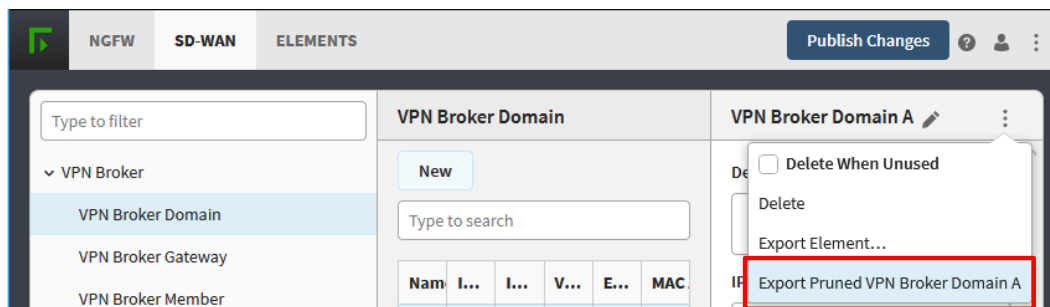

- 2) Select the VPN Broker Domain element that you want to export, then click **:** > **Export Pruned <name>**.  
The **Export Pruned** option exports only the parts of the VPN Broker Domain configuration that are needed for creating a VPN Broker Domain element in the SMC. The exported configuration includes the VPN Broker Domain and the VPN Broker Members.
- 3) Save the .zip file to your local workstation.

## Next steps

In each NGFW Manager, enable the VPN configuration in the properties of the NGFW Engine.

# Enable the VPN configuration in each NGFW Manager

In each NGFW Manager, enable the VPN configuration in the properties of the NGFW Engine.

## Steps

- 1) Browse to **NGFW > Properties**.
- 2) Browse to the **VPN** section, then select **VPN Configuration**.
- 3) To add a row to the **VPN Gateways** table, click **⋮ > Add**.
- 4) In the **VPN Gateway** cell, add the VPN Broker Gateway element that you created.  
Type part of the name of an element or browse through the drop-down list to select an element.
- 5) Under **VPN Gateway Settings**, add the Gateway Default Settings element.  
Type part of the name of an element or browse through the drop-down list to select an element.
- 6) Click **Save**.
- 7) If you have not yet viewed or edited the Access policy, at the top-right corner of the user interface click:
 

Finalize the setup
- 8) To publish your changes in the NGFW Manager, at the top-right corner of the user interface, click:
 

Publish Changes

Fields marked with an asterisk \* in the user interface are mandatory.

NGFW Engine Properties - VPN	
Option	Definition
<b>VPN Configuration</b>	When selected, enables the VPN options.
<b>VPN Gateways</b>	Shows the configured VPN gateways. Click <b>⋮ &gt; Add</b> to add a row to the table.
<b>Gateway</b>	The VPN Gateway element that represents the physical gateway device. Type part of the name of an element or browse through the drop-down list to select an element.
<b>VPN Client Settings</b>	This option is not yet supported.
<b>SSL VPN Settings</b>	This option is not yet supported.
<b>Automatic Certificate Management</b>	This option is not yet supported.
<b>Automatic Sites From Routing</b>	This option is not yet supported.
<b>VPN Gateway Settings</b>	The VPN Gateway Settings element defines performance-related VPN options. Type part of the name of an element or browse through the drop-down list to select an element.

## Next steps

You have now finished the configuration steps in the NGFW Manager. Next, create elements for the VPN Broker high availability configuration in the SMC.

# Create elements for the VPN Broker high availability configuration in the SMC

You must create the elements that represent the VPN Broker configuration in the SMC.

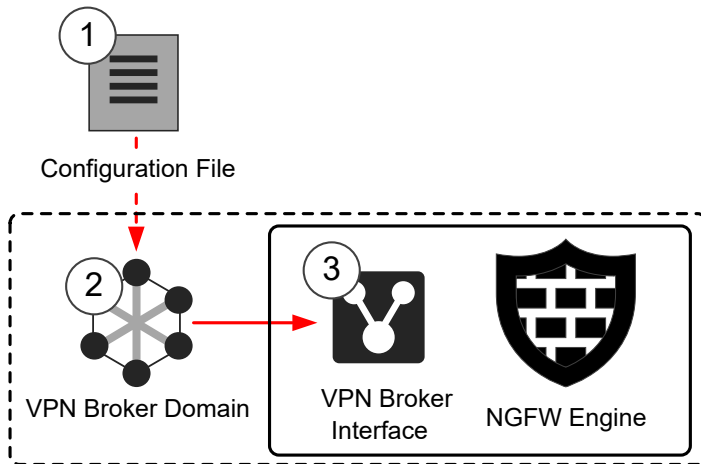

- 1 The configuration file for the VPN Broker Domain is exported from the NGFW Manager.
- 2 The configuration file that you exported from the NGFW Manager is used in the VPN Broker Domain element.
- 3 The VPN Broker Interface is a virtual interface in the configuration of the NGFW Engine. The VPN Broker interface allows the NGFW Engine to act as a member of the VPN Broker domain.

## Next steps

Begin by creating a VPN Broker Domain element in the SMC.

# Create one VPN Broker Domain element in the SMC

Create one VPN Broker Domain element and import the exported configuration file from the NGFW Manager.



### Note

The configuration of the VPN Broker Domain element must contain information about all VPN Broker gateways and VPN Broker members in the same VPN Broker domain.

**Steps** For more details about the product and how to configure features, click **Help** or press **F1**.

1) Open the Management Client.

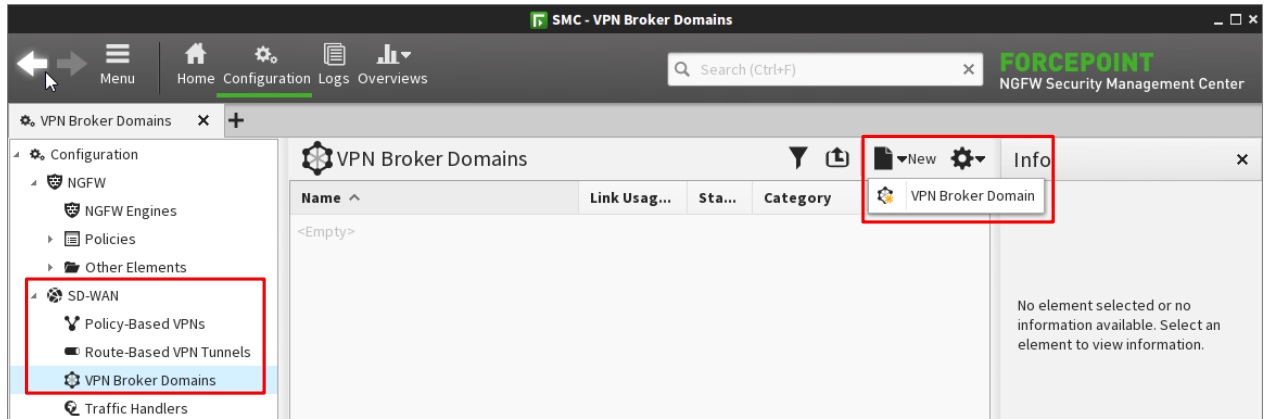

2) Select **Configuration**, then browse to **SD-WAN**.

3) Browse to **VPN Broker Domains**.

4) Select **New > VPN Broker Domain**.

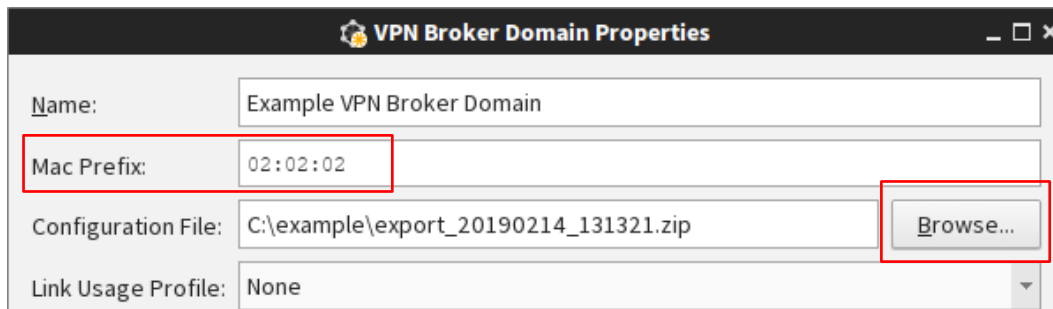

5) Configure the settings.

a) (Optional) Enter a name for the element.

If you do not enter a name, the name is automatically generated based on the name of the configuration file.

b) In the **Mac Prefix** field, enter the first three octets of the MAC address that is used by all members of the VPN Broker domain.

This MAC address prefix must be the same as the MAC address prefix that is used in the VPN Broker Domain element that you created in the NGFW Manager.

c) Next to the **Configuration File** field, click **Browse**, then select the configuration file that you exported from the NGFW Manager.

d) Click **OK**.

VPN Broker Domain properties	
Option	Definition
<b>Name</b> (Optional)	The name of the element.
<b>Mac Prefix</b>	Enter the first three octets of the MAC address that is used by all members of the VPN Broker domain. This MAC address prefix must be the same as the MAC address prefix that is used in the VPN Broker Domain element that you created in the NGFW Manager.
<b>Configuration File</b>	Click <b>Browse</b> to select the configuration file that you exported from the NGFW Manager.
<b>Link Usage Profile</b> (Optional)	To use dynamic link selection for Multi-Link VPNs, select a Link Usage Profile element.  When you select a Link Usage Profile element in the properties of a policy-based VPN, route-based VPN tunnel group, or a VPN broker domain, the settings defined in the Link Usage Profile element are applied to all tunnels in the VPN according to their link types.

## Next steps

Add a VPN Broker Interface to all NGFW Engines that are used as VPN Broker members.

# Add a VPN Broker Interface to each NGFW Engine

You must add a VPN Broker Interface to each NGFW Engine that is used as a VPN Broker member so that the VPN Broker can communicate with the members of a VPN Broker domain.

**Steps**  For more details about the product and how to configure features, click **Help** or press **F1**.

- 1) In the Management Client, select  **Configuration**.

- 2) Right-click an NGFW Engine, then select **Edit <element type>**.

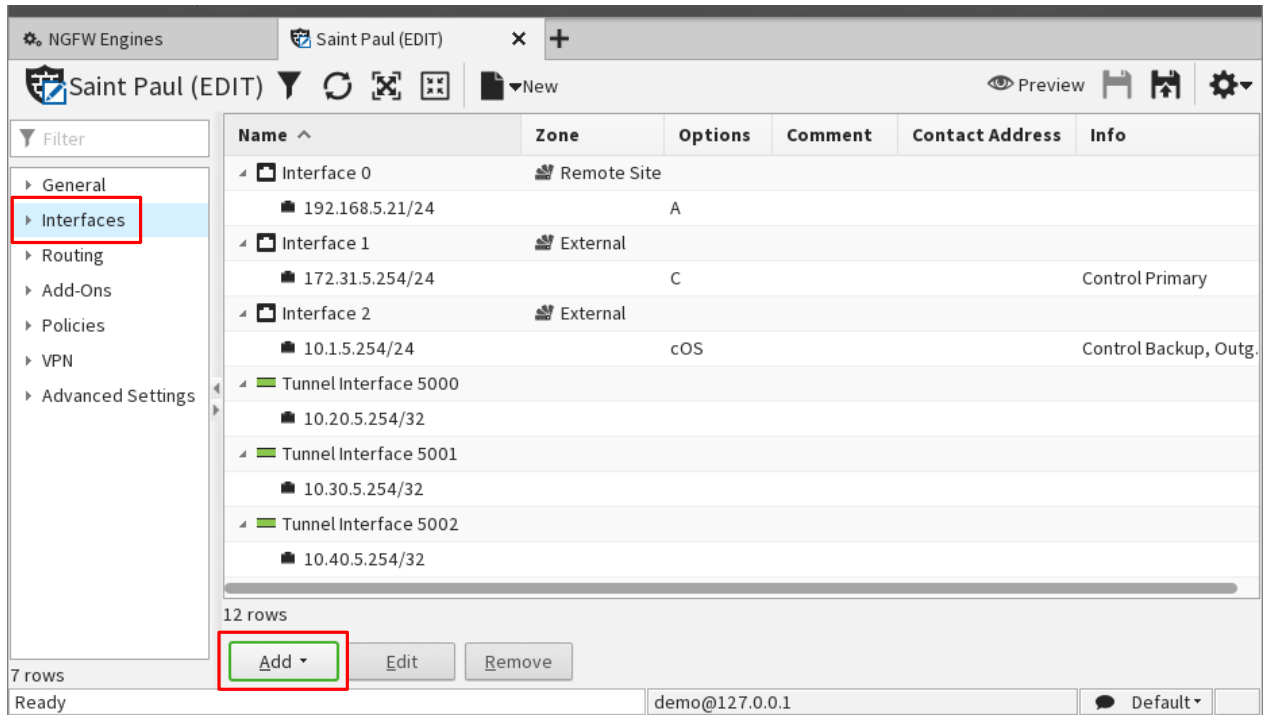



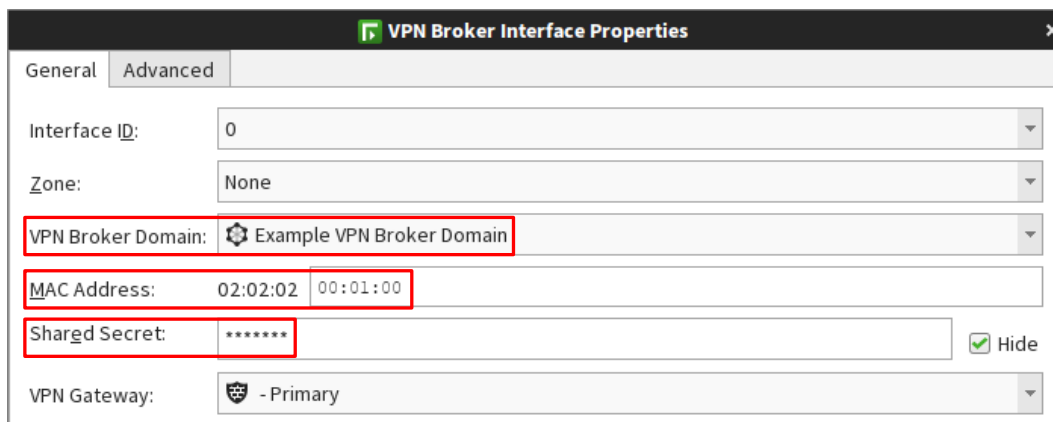

- 3) Browse to **Interfaces**.
- 4) Click **Add > VPN Broker Interface**.
- 5) Configure the settings.



- a) From the **VPN Broker Domain** drop-down list, select the VPN Broker Domain element that you created.
- b) In the **MAC Address** field, enter the last three octets of the MAC address for the VPN Broker member. This MAC address must be the same as the MAC address used in the corresponding VPN Broker Member element that you created in the NGFW Manager.
- c) In the **Shared Secret** field, enter the same password that you entered for the VPN Broker Member element in the NGFW Manager.

- d) Click **OK**.
- 6) Right-click the VPN Broker Interface, then select **New > IPv4 Address** or **New > IPv6 Address**.
- 7) Enter the IP address used in the corresponding VPN Broker Member element, then click **OK**.
- 8) Click  **Save and Refresh**, then click **OK** to transfer the changes to the NGFW Engine.

VPN Broker Interface properties	
Option	Definition
<b>General tab</b>	
<b>Interface ID</b>	The ID number that identifies the VPN Broker Interface.  The VPN Broker Interface is a virtual interface that is used only for the VPN Broker. The interface ID of the VPN Broker Interface can be the same as the interface ID of a physical interface on the same NGFW Engine.
<b>Zone (Optional)</b>	Select the network zone to which the interface belongs. Click <b>Select</b> to select an element, or click <b>New</b> to create an element.
<b>VPN Broker Domain</b>	Select the VPN Broker Domain element that you created.
<b>MAC Address</b>	<div style="border: 1px solid #ccc; background-color: #f9f9f9; padding: 5px; margin-bottom: 10px;">  <b>Note</b>                      The MAC address prefix for the VPN Broker Domain is automatically added based on the VPN Broker Domain element.                 </div> Enter the last three octets of the MAC address for the VPN Broker member. This MAC address must be the same as the MAC address used in the corresponding VPN Broker Member element that you created in the NGFW Manager.
<b>Shared Secret</b>	Enter the password. The password must be the same as the shared secret that you entered for the VPN Broker Member element in the NGFW Manager. By default, passwords and keys are not shown in plain text. To show the password or key, deselect the <b>Hide</b> option.
<b>VPN Gateway</b>	Select the local VPN gateway.
<b>Retrieve Routes from VPN Broker</b>	When selected, the routing table is updated with routes that are retrieved by the VPN Broker.
<b>Adjust Antispoofing according to retrieved routes</b>	When selected, antispoofing rules are automatically adjusted based on the routes that are retrieved by the VPN Broker.
<b>QoS Mode (Optional)</b>	Defines how QoS is applied to the link on this interface.  If <b>Full QoS</b> or <b>DSCP Handling and Throttling</b> is selected, a QoS policy must also be selected. If <b>Full QoS</b> is selected, the throughput must also be defined.  If the interface is a Physical Interface, the same QoS mode is automatically applied to any VLANs created under it.

Option	Definition
<p><b>QoS Policy</b></p>	<p><i>(When QoS Mode is Full QoS or DSCP Handling and Throttling)</i></p> <p>The QoS policy for the link on this interface.</p> <p>If the interface is a Physical Interface, the same QoS policy is automatically selected for any VLANs created under it.</p> <div data-bbox="451 373 506 426" style="float: left; margin-right: 10px;">  </div> <div data-bbox="537 373 1469 531" style="border: 1px solid #ccc; padding: 5px; background-color: #f9f9f9;"> <p><b>Note</b></p> <p>If a Virtual Resource has a throughput limit defined, the interfaces on the Virtual NGFW Engine that use a QoS policy all use the same policy. The policy used in the first interface is used for all the interfaces.</p> </div>
<p><b>Interface Throughput Limit</b></p>	<p><i>(When QoS Mode is Full QoS)</i></p> <p>Enter the throughput for the link on this interface as megabits per second.</p> <p>If the interface is a Physical Interface, the same throughput is automatically applied to any VLANs created under it.</p> <p>The throughput is for uplink speed (outgoing traffic) and typically must correspond to the speed of an Internet link (such as an ADSL line), or the combined speeds of several such links when connected to a single interface.</p> <div data-bbox="451 846 506 898" style="float: left; margin-right: 10px;">  </div> <div data-bbox="537 846 1469 1035" style="border: 1px solid #ccc; padding: 5px; background-color: #f9f9f9;"> <p><b>CAUTION</b></p> <p>Make sure that you set the interface speed correctly. When the bandwidth is set, the NGFW Engine always scales the total amount of traffic on this interface to the bandwidth you defined. This scaling happens even if there are no bandwidth limits or guarantees defined for any traffic.</p> </div> <div data-bbox="451 1066 506 1119" style="float: left; margin-right: 10px;">  </div> <div data-bbox="537 1066 1469 1255" style="border: 1px solid #ccc; padding: 5px; background-color: #f9f9f9;"> <p><b>CAUTION</b></p> <p>The throughput for a Physical Interface for a Virtual NGFW Engine must not be higher than the throughput for the Master NGFW Engine interface that hosts the Virtual NGFW Engine. Contact the administrator of the Master NGFW Engine before changing this setting.</p> </div>
<p><b>MTU</b> (Optional)</p>	<p>The maximum transmission unit (MTU) size on the connected link. Either enter a value between 400–65535 or select a common MTU value from the list.</p> <p>If the interface is a Physical Interface, the same MTU is automatically applied to any VLANs created under it.</p> <p>The default value (also the maximum standard MTU in Ethernet) is 1500. Do not set a value larger than the standard MTU, unless you know that all devices along the communication path support it.</p> <p>To set the MTU for a Virtual NGFW Engine, you must configure the MTU for the interface on the Master NGFW Engine that hosts the Virtual NGFW Engine, then refresh the policy on the Master NGFW Engine and the Virtual NGFW Engine.</p>

## Next steps

Check the status of the VPN Broker.



# Check the status of the VPN Broker

To make sure that the components in the VPN Broker configuration are working correctly, check the status of the VPN Broker in the Management Client component of the SMC or on the command line of the NGFW Engine.

For more information about the monitoring features in the Management Client, see the *Forcepoint Next Generation Firewall Product Guide*.

## Steps

- 1) Check the status in one or more of the following ways:
  - In the Home view of the Management Client, select an NGFW Engine to check the status of the connection between the NGFW Engine and the VPN Broker gateway. The **Status** tab of the **Info** pane shows the status.

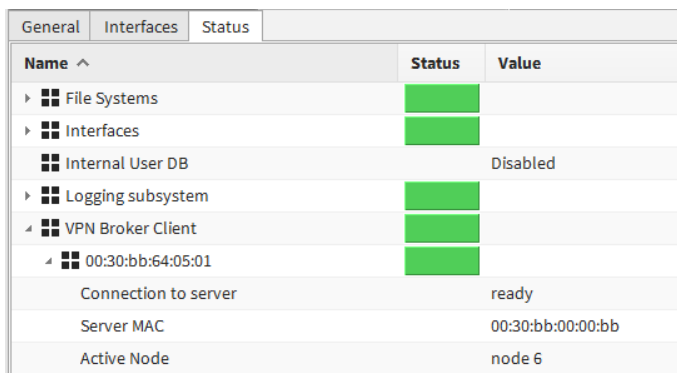

### Note

This status information is not available for Virtual NGFW Engines.

- In the Logs view of the Management Client, use the VPN Broker facility in a filter to show logs related to the VPN Broker.

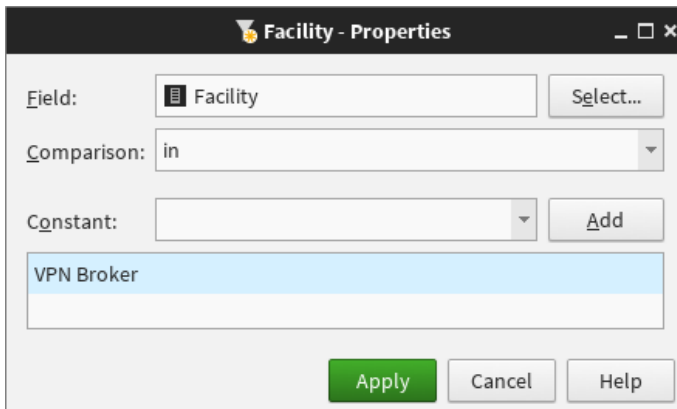

The following situations appear in log entries related to the VPN Broker:

Situation	Description
VPN-Broker_Client-Request	A VPN Broker member sent an information request to a VPN Broker gateway.
VPN-Broker_Connection_Error	The connection with the VPN Broker gateway has not been established.
VPN-Broker_Connection_Established	The connection with the VPN Broker gateway has been established.

- When VPN tunnels have been established between VPN Broker members, check the status of the tunnels in the SD-WAN dashboard in the Home view of the Management Client.
- On the command line of an NGFW Engine, enter the following command:

```
sg-brokerctl -s
```

On an NGFW Engine that acts as a VPN Broker gateway, the command shows a summary of the status of the connections between the VPN Broker members and the VPN Broker gateway. In a high availability environment, you can see if the VPN Broker gateways can be contacted. The age shown in the output should be 5 seconds or less. To check that the members have been synchronized correctly, you can enter `sg-brokerctl info` to check that the hash for `primary_member_hash` and `member_hash` match.

On an NGFW Engine that acts as a VPN Broker member, the command shows which other VPN Broker members the NGFW Engine can connect to, and shows the status of the connection between the NGFW Engine and the VPN Broker gateway.

## Result

You have now finished configuring the VPN Broker.

# Part III

## Local management of a single NGFW Engine

### Contents

- [Setting up the NGFW Engine for local management on page 77](#)
- [Monitoring the NGFW Engine on page 103](#)
- [Configuring other NGFW Engine properties on page 105](#)

You can use the Forcepoint NGFW Manager to locally manage a single NGFW Engine.



## Chapter 4

# Setting up the NGFW Engine for local management

### Contents

- Example deployment scenario for a single NGFW Engine on page 77
- Limitations of local management of single NGFW Engines on page 78
- NGFW Engine configuration overview on page 78
- Start the NGFW Manager on page 79
- Select the mode in the NGFW Manager on page 80
- Create elements to use for NGFW Engine configuration on page 81
- Configure interfaces for connections to other networks on page 82
- Edit the Access policy on page 85
- Edit the NAT policy on page 88
- Select the Inspection policy for the NGFW Engine on page 90
- Configure SSH access to the NGFW Engine command line on page 90
- Configure NTP on page 91
- Configure DNS on page 92
- Configure the NGFW Engine tester on page 93
- Change the IP address of the interface for control connections on page 99
- Create other elements for NGFW Engine configuration on page 100

To use the NGFW Manager for local management of a single NGFW Engine, configure the necessary settings for the NGFW Engine.



#### Note

It is not possible use local management for NGFW Engines that are used as VPN Broker members. You must configure and manage NGFW Engines that are used as VPN Broker members using the Management Client component of the SMC.

## Example deployment scenario for a single NGFW Engine

The NGFW Engine is a perimeter defense, positioned between networks with different security levels. This scenario shows an example of using the NGFW Engine to restrict traffic between different internal networks in an isolated network environment.

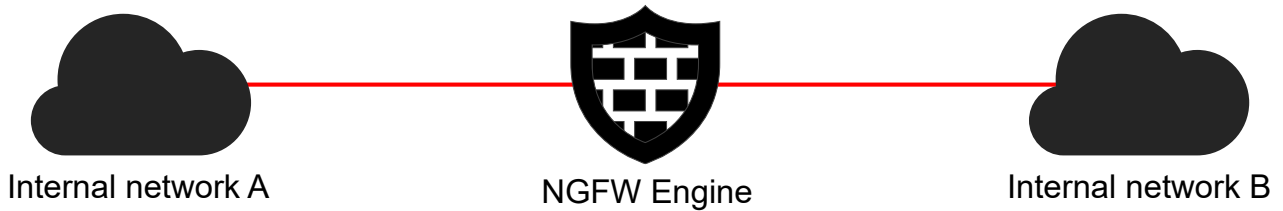

The NGFW Engine separates the different internal networks by enforcing rules that control access from one network to another. The NGFW Engine establishes boundaries between networks to protect sensitive data and essential services.

## Limitations of local management of single NGFW Engines

The NGFW Manager has some restrictions and limitations.



### Note

This document describes the currently supported features and options. Some features and options that are not yet supported might appear in the user interface.

Some features require Internet connectivity.

The following configuration options and features are not yet available in this release:

- Antivirus and McAfee GTI scans for file filtering
- Log forwarding
- Policy routing
- ThreatSeeker Cloud URL categorization
- TLS inspection
- Tunnel interfaces

VPNs are not yet supported in NGFW Engine Management mode. To use the VPN Broker, you must use VPN Broker Management mode.

## NGFW Engine configuration overview

The NGFW Engine configuration consists of several general steps.

- 1) Configure interfaces and routing.
  - a) Create elements to use for interface configuration.
  - b) Add IP addresses to interfaces for connections to other networks.
  - c) For networks that are not directly connected to the NGFW Engine, configure routing.

- 2) Configure policies.
  - a) Add rules to the Access policy.
  - b) (Optional) Select the Inspection policy for the NGFW Engine.
- 3) (Optional) To allow secure remote connections to the command line of the NGFW Engine, configure SSH access.
- 4) (Optional) To enable automatic time synchronization for the NGFW Engine, configure NTP.

**Note**

This feature requires Internet connectivity.

- 5) (Optional) To allow the NGFW Engine to translate domain names to IP addresses, configure DNS.

**Note**

This feature requires Internet connectivity.

## Start the NGFW Manager

The NGFW Configuration Wizard allows you to configure settings for the Forcepoint NGFW appliance. Start the NGFW Manager from the web browser version of the NGFW Configuration Wizard.

### Steps

- 1) Connect the NGFW appliance to a laptop or other client device.  
Connect an Ethernet cable from the client device to physical port eth0\_1 on the NGFW appliance. If the NGFW appliance does not have a port eth0\_1, use port eth1\_0. If using non-modular interfaces, use port eth1.
- 2) Connect the other network cables to the Forcepoint NGFW appliance.
- 3) Turn on the Forcepoint NGFW appliance.
- 4) To start the web browser version of the NGFW Configuration Wizard, open a web browser on the client device, then connect to `https://169.254.169.169`.  
It might take some time for the web page to load.
- 5) When the NGFW Configuration Wizard offers a web browser client certificate, accept the certificate.
- 6) On the Welcome page of the NGFW Configuration Wizard, click **Start**.
- 7) Select **I Agree to the Terms and Conditions**, then click **Next**.

- 8) Enter and confirm the password for the root account, then click **Next**.

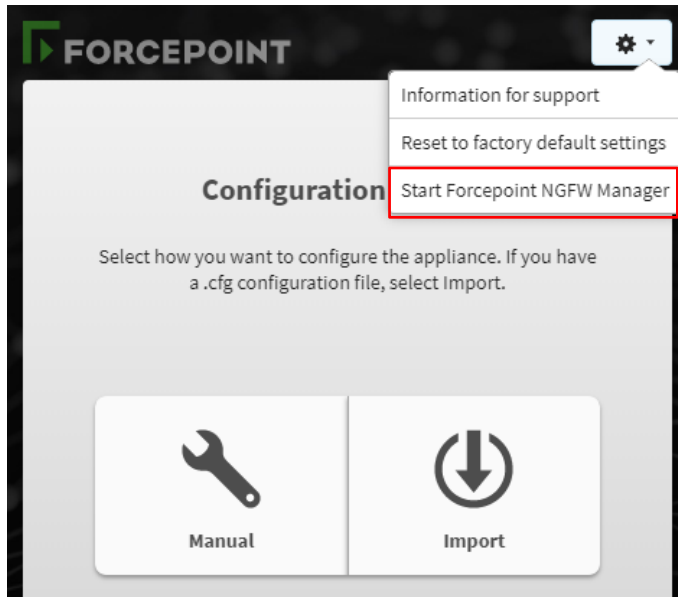

- 9) Click **⚙** > **Start Forcepoint NGFW Manager** to restart the appliance.
- 10) After the NGFW appliance has restarted, refresh the web browser to start the NGFW Manager.
- 11) Enter `root` as the user name, enter the password for the root account, then click **Log In**.

## Next steps

Continue by selecting the mode in the NGFW Manager.

# Select the mode in the NGFW Manager

Modes in the NGFW Manager allow you to either configure the VPN Broker or locally manage a single NGFW Engine.

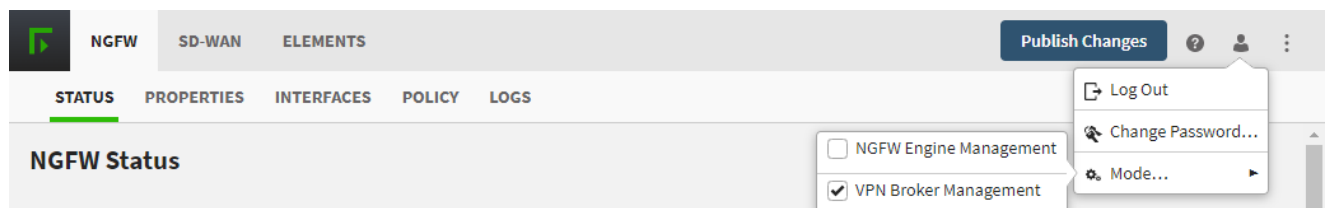

## Steps

- 1) Select **User** > **⚙ Mode**, then select the mode.
- **VPN Broker Management** — Allows you to configure the VPN Broker. In this mode, elements and options related to the VPN Broker are shown in addition to elements and options related to the management of the NGFW Engine.



- **NGFW Engine Management** — Allows you to locally manage a single NGFW Engine. In this mode, elements and options related to the VPN Broker are not shown.

## Next steps

Continue the configuration in one of the following ways:

- If you are configuring the VPN Broker, configure an interface for members of the VPN Broker domain.
- If you are locally managing a single NGFW Engine, create elements to use for NGFW Engine configuration.

# Create elements to use for NGFW Engine configuration

Create reusable elements to use in the configuration of the NGFW Engine.

To configure interfaces and routing to networks that are not directly connected to the NGFW Engine, create a Router element to represent your network switch or router, and Network elements to represent the other networks.

To configure SSH access to the command line of the NGFW Engine, create Host or Network elements to define the IP addresses from which SSH connections to the NGFW Engine are allowed.

## Steps

- 1) Browse to **Elements > Network Elements > <element type>**.
- 2) Click **New**.
- 3) Configure the settings, then click **Save**.

Fields marked with an asterisk \* in the user interface are mandatory.

Host properties	
Option	Definition
IP List	Enter one IP address for the host. Enter one IP address per row. If you have a list of IP addresses where each IP address is on a separate row, you can copy and paste the list. To remove a row, click  <b>Remove</b> next to the row. To remove all rows, click <b>Clear All</b> .

Network element	
Option	Definition
IPv4 Network	Enter the IPv4 address and netmask in CIDR notation. You must enter either an IPv4 or IPv6 network.
IPv6 Network	Enter the IPv6 address and prefix length in CIDR notation. You must enter either an IPv4 or IPv6 network.
Broadcast	When selected, includes the broadcast address and the network address in the definition. The broadcast address is only used when you use the Network element in the Source and Destination cells in rules.

Router element	
Option	Definition
IP List	Enter one or more IP addresses for the router. Enter one IP address per row. If you have a list of IP addresses where each IP address is on a separate row, you can copy and paste the list. To remove a row, click  <b>Remove</b> next to the row. To remove all rows, click <b>Clear All</b> .

# Configure interfaces for connections to other networks

Interfaces for each Ethernet port on the NGFW appliance are automatically included in the interface table. You must add IP addresses and configure routing for connections to other networks.

**Before you begin**

If the other network is not directly connected to the NGFW Engine, create a Router element to represent your network switch or router and a network element to represent the other network.

 **CAUTION**

The interface for control connections can only have one IP address. Do not add additional IP addresses or VLANs to the interface for control connections.

## Steps

- 1) Browse to **NGFW > Interfaces**.

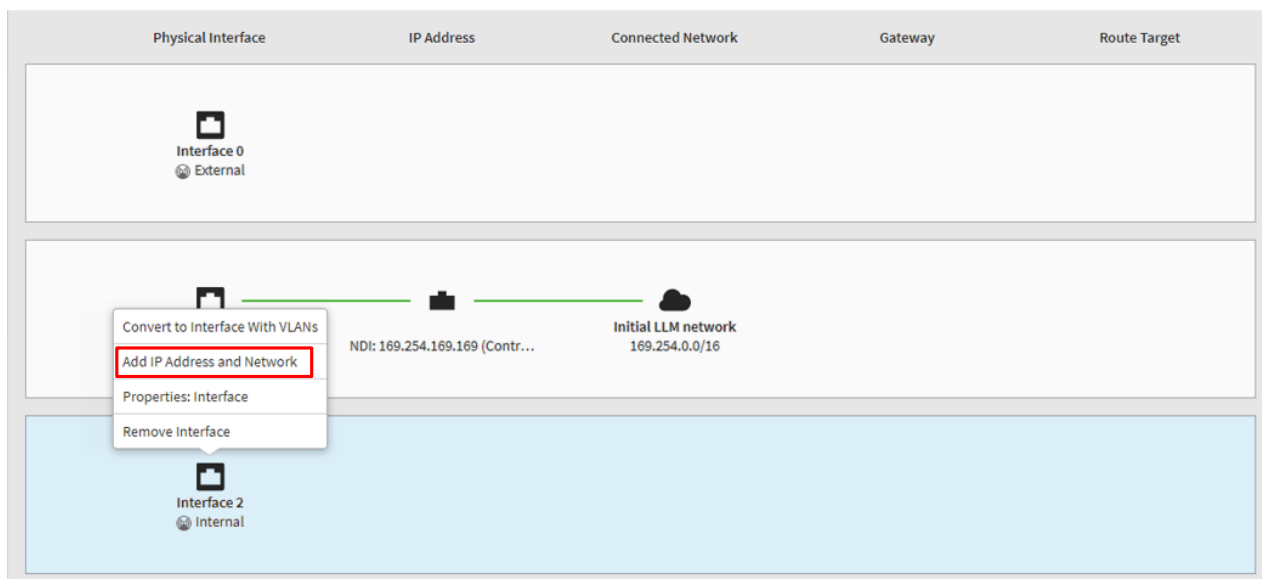

- 2) In the interface table below the appliance image, click an interface, then select **Add IP Address and Network**.
- 3) Enter the IP address and netmask in CIDR notation, then click **Save**.  
Example: 192.168.1.1/24
- 4) If the network is not directly connected to the NGFW Engine, configure routing.
  - a) Click the connected network, select **Add Gateway**, then select your Router element.
  - b) Click the gateway, select **Add Route Target**, then select your Network element.
- 5) Continue the configuration in one of the following ways:
  - If you are configuring interfaces for the first time, click:
 

Finalize the setup
  - Otherwise, click:
 

Publish Changes

Fields marked with an asterisk \* in the user interface are mandatory.

Interfaces & Routing page	
Option	Definition
<div style="border: 1px solid #ccc; background-color: #f0f0f0; padding: 5px; display: inline-block;">New</div>	Adds an interface to the interfaces table. If you change the number of Ethernet ports on the NGFW appliance, such as by replacing a 4-port interface module with an 8-port interface module, you must add interfaces to represent the new Ethernet ports. <ul style="list-style-type: none"> <li>■ <b>Interface</b> — Adds a physical interface. Opens the <b>New Interface</b> dialog.</li> <li>■ <b>Interface with VLANs</b> — Adds a physical interface with a placeholder for adding VLAN interfaces later. Opens the <b>New Interface With VLANs</b> dialog.</li> <li>■ <b>Tunnel Interface</b> — This option is not yet supported.</li> </ul>
Appliance image	Shows the ports on the NGFW appliance for which you can configure interfaces. When you select an interface in the interface table, the corresponding port is highlighted in the image.
Interface table	Allows you to configure the IP addresses, networks, and routing for each interface.
<b>Physical Interface</b>	( <i>When interface type is Physical Interface</i> ) Shows the interface ID of the physical interfaces. The following actions are available when you click the interface: <ul style="list-style-type: none"> <li>■ <b>Add IP Address and Network</b> — Adds an IP address and a Network element to the interface. Opens the <b>New IP Address and Netmask</b> dialog box.</li> <li>■ <b>Convert to Interface With VLANs</b> — Removes any IP addresses that have been specified and converts the interface to an interface with VLANs.</li> <li>■ <b>Properties: Interface</b> — Opens the interface properties.</li> <li>■ <b>Remove Interface</b> — Removes the interface from the configuration.</li> </ul>

Option	Definition
<b>Physical Interface</b>	<p><i>(When interface type is Physical Interface with VLAN interfaces)</i></p> <p>Shows the interface ID of the physical interfaces and the VLAN interfaces under them. The following actions are available when you click the physical interface:</p> <ul style="list-style-type: none"> <li>■ <b>Add VLAN Interface</b> — Adds a VLAN interface.</li> <li>■ <b>Convert to Interface</b> — Converts the interface with VLANs to an interface. There can be a maximum of one VLAN Interface when you convert the interface.</li> <li>■ <b>Properties: Interface with VLANs</b> — Opens the interface properties.</li> <li>■ <b>Remove Interface</b> — Removes the interface from the configuration.</li> </ul> <p>The following actions are available when you click the VLAN interface:</p> <ul style="list-style-type: none"> <li>■ <b>Add IP Address and Network</b> — Adds an IP address and a Network element to the interface. Opens the <b>New IP Address and Netmask</b> dialog box.</li> <li>■ <b>Properties: VLAN Interface</b> — Opens the VLAN interface properties.</li> <li>■ <b>Remove VLAN Interface</b> — Removes the VLAN interface.</li> </ul>
<b>IP Address</b>	<p>Shows the IP address of the physical interface or VLAN interface. The following actions are available when you click the IP address:</p> <ul style="list-style-type: none"> <li>■ <b>Properties: Static Address</b> — Allows you to add a static IP address to the interface.</li> <li>■ <b>Remove IP Address and Network</b> — Removes the IP address from the interface configuration.</li> </ul>
<b>Connected Network</b>	<p>Shows the network range of the directly connected network. The following options are available when you click the network:</p> <ul style="list-style-type: none"> <li>■ <b>Add Gateway</b> — Allows you to add a route through a gateway device to a network that is not directly connected.</li> <li>■ <b>Properties: Network</b> — Opens the properties of the Network element.</li> </ul>
<b>Gateway</b>	<p>Shows the gateway device through which the NGFW Engine connects to a network that is not directly connected. The following actions are available when you click the gateway:</p> <ul style="list-style-type: none"> <li>■ <b>Add Route Target</b> — Allows you to specify the IP addresses that are reachable through the gateway device.</li> <li>■ <b>Properties: &lt;element type&gt;</b> — Opens the properties of the element that represents the gateway device.</li> <li>■ <b>Remove Gateway</b> — Removes the gateway device from the interface configuration. The element is not deleted.</li> </ul>
<b>Route Target</b>	<p>Shows the IP addresses that are reachable through the gateway device. The following options are available when you click the route target:</p> <ul style="list-style-type: none"> <li>■ <b>Properties: &lt;element type&gt;</b> — Opens the properties of the element that represents the IP addresses.</li> <li>■ <b>Remove Route Target</b> — Removes the route target from the interface configuration. The element is not deleted.</li> </ul>

#### Interface properties

Option	Definition
<b>Interface ID</b>	<p><i>(When interface type is Physical Interface)</i></p> <p>The Interface ID automatically maps to a physical network port on the appliance.</p>

Option	Definition
<b>VLAN ID</b>	<i>(When interface type is VLAN Interface)</i> Specifies the VLAN ID (1–4094). The VLAN IDs must be the same as the VLAN IDs that are used in the switch at the other end of the VLAN trunk. Each VLAN Interface is identified as Interface-ID.VLAN-ID, for example, 2.100 for Interface ID 2 and VLAN ID 100.
<b>Interface Options (Optional)</b>	Advanced options for interface configuration.
<b>MTU</b>	The maximum transmission unit (MTU) size on the connected link. Enter a value between 576–65000.
<b>Zone</b>	The network zone to which the interface belongs. By default, Interface 0 belongs to the external zone. All other interfaces belong to the internal zone.
<b>Antispoofing Elements</b>	This option is not yet supported.
<b>Route Replies Back</b>	This option is not yet supported.

## Next steps

If you are configuring the NGFW Engine for the first time, configure the policy for the NGFW Engine.

# Edit the Access policy

The Access policy defines which connections are allowed.

By default, the Access policy contains one rule for testing connectivity that allows HTTP, HTTPS, and ping traffic from all interfaces that belong to the internal zone to any destination. Log entries related to this traffic are stored on the NGFW Engine.

You can edit this rule and add other rules. By default, the NGFW Engine blocks all connections that have not been specifically allowed in the Access policy.

### Default rule in the Access policy

Name	Source	Destination	Service	Logging	Action
Connectivity Testing	Internal Zone	ANY	HTTP, HTTPS, Ping	Stored	Allow

## Steps

- 1) Browse to **NGFW > Policy > Access** or **NGFW > Policy > NAT**.
- 2) Add a rule in one of the following ways:
  - Click **+** **Add First Rule**.
  - Click a rule, select **...** > **New**, then select **Rule Before** or **Rule After**.
- 3) Configure the settings, then click **Save**.
- 4) Publish the changes.

Fields marked with an asterisk \* in the user interface are mandatory.

Access Policy	
Option	Definition
<b>Source and Destination</b>	A set of matching criteria that defines the IP addresses and interfaces that the rule matches. <ul style="list-style-type: none"> <li>■ Type part of the name of an element or browse through the drop-down list to select an element.</li> <li>■ Click <b>Set to ANY</b> to match any element.</li> </ul>
<b>Service</b>	A set of matching criteria that matches traffic based on the Network Application, or protocol and port. <ul style="list-style-type: none"> <li>■ Type part of the name of an element or browse through the drop-down list to select an element.</li> <li>■ Click <b>Set to ANY</b> to match any element.</li> </ul>
<b>Logging</b>	Defines logging options for the rule. <ul style="list-style-type: none"> <li>■ <b>Logging</b> — When selected, enables logging for the rule.</li> <li>■ <b>Log Level</b> — Defines the log level for matching connections.                             <ul style="list-style-type: none"> <li>■ <b>None</b> — Does not create any log entry</li> <li>■ <b>Transient</b> — Creates a log entry that is shown on the Logs tab, but is not stored.</li> <li>■ <b>Stored</b> — Creates a log entry that is stored on the NGFW Engine.</li> <li>■ <b>Essential</b> — Creates a log entry that is shown on the Logs tab and saved for further use.</li> <li>■ <b>Alert</b> — Triggers an alert with the severity that you define.</li> <li>■ <b>Automatic</b> — This option is not supported in the Access policy.</li> </ul> </li> <li>■ <b>Severity</b> — When the <b>Log Level</b> is set to <b>Alert</b>, defines the severity of the alert.</li> <li>■ <b>Advanced Options</b> — Allows you to define advanced logging options.</li> </ul>
<b>Action</b>	Command for the engine to carry out when a connection matches the rule. <ul style="list-style-type: none"> <li>■ <b>Allow</b> — Allows connections that match the rule.</li> <li>■ <b>Discard</b> — Discards connections that match the rule.</li> <li>■ <b>Continue</b> — Sets default options for traffic matching. The options are used for later rules that match the same criteria unless the later rules override the options.</li> <li>■ <b>Refuse</b> — Refuses connections that match the rule.</li> <li>■ <b>Jump</b> — The rule processing jumps to a Sub-Policy to continue processing rules.</li> <li>■ <b>Use VPN</b> — Connections that match the rule are sent into the specified VPN.</li> <li>■ <b>Decryption</b> — This option is not yet supported.</li> <li>■ <b>Advanced Options</b> — Allows you to define advanced action options.</li> </ul>

#### Advanced Logging options

Option	Definition
<b>Log Level</b>	Defines the log level for matching connections.
<b>Severity</b>	When the <b>Log Level</b> is set to <b>Alert</b> , defines the severity of the alert.
<b>Connection Closing</b>	Specifies how log entries are created when connections are closed. <ul style="list-style-type: none"> <li>■ <b>None</b> — No log entries are created.</li> <li>■ <b>Normal</b> — Both connection opening and closing are logged, but no information about the volume of traffic is collected.</li> <li>■ <b>Accounting</b> — Both connection opening and closing are logged and information about the volume of traffic is collected.</li> </ul>

Option	Definition
<b>Log User</b>	<p>Defines whether information about users is included in the log data.</p> <ul style="list-style-type: none"> <li>■ <b>Off</b> — Information about users is not included in the log data.</li> <li>■ <b>Default</b> — Information about users is included in the log data if information about the user is cached for the connection. Otherwise, only the IP address associated with the user at the time the log is created is included in the log data. Access control by user must be enabled.</li> <li>■ <b>Enforced</b> — Information about users is always included in the log data if information about the user is available in the user database. If information about the user is not cached for the connection, the NGFW Engine resolves the user information from the IP address. Access control by user must be enabled.</li> </ul>
<b>Log Application</b>	<p>Defines whether information about Application detection is included in the log data.</p> <ul style="list-style-type: none"> <li>■ <b>Off</b> — Information about Application detection is not included in the log data.</li> <li>■ <b>Default</b> — Information about Application detection is included in the log data if the information is available without additional inspection.</li> <li>■ <b>Enforced</b> — Information about Application detection is always included in the log data if the Application can be identified.</li> </ul>
<b>Log URL Category</b>	<p>Defines whether information about URL categorization is included in the log data.</p> <ul style="list-style-type: none"> <li>■ <b>Off</b> — URL categories are not included in the log data.</li> <li>■ <b>Default</b> — URL categories are included in the log data for matching traffic when URL Categories are used as matching criteria in the rule.</li> <li>■ <b>Enforced</b> — URL categories are always included in the log data if the URL category can be identified.</li> </ul>

#### Advanced Action options

Option	Definition
<b>Deep Inspection</b>	<p>Selects traffic that matches this rule for checking against the Inspection Policy.</p> <ul style="list-style-type: none"> <li>■ <b>On</b> — The feature is enabled.</li> <li>■ <b>Off</b> — The feature is disabled.</li> </ul>
<b>File Filtering</b>	<p>This option is not yet supported.</p>
<b>Conntrack Mode</b>	<ul style="list-style-type: none"> <li>■ <b>Off</b> — The feature is disabled.</li> <li>■ <b>Default</b> — The settings defined in the NGFW Engine properties are used.</li> <li>■ <b>Loose</b> — Reply packets are allowed as part of the allowed connection without an explicit Access rule. The NGFW Engine allows some connection patterns and address translation operations that are not allowed in Normal mode.</li> <li>■ <b>Normal</b> — Reply packets are allowed as part of the allowed connection without an explicit Access rule. The NGFW Engine drops ICMP error messages related to connections that are not currently active in connection tracking (unless explicitly allowed by a rule in the policy). A valid, complete TCP handshake is required for TCP traffic. The NGFW Engine checks the traffic direction and the port parameters of UDP traffic. If the Service cell in the rule contains a Service that uses a Protocol Agent, the NGFW Engine also validates TCP and UDP traffic on the application layer. If a protocol violation occurs, the packet that violates the protocol is dropped.</li> <li>■ <b>Strict</b> — Reply packets are allowed as part of the allowed connection without an explicit Access rule. The NGFW Engine allows only TCP traffic that strictly adheres to the TCP standard as defined in RFC 793. The NGFW Engine also checks the sequence numbers of the packets in pre-connection establishment states and for RST and FIN packets, and drops packets that are out of sequence. If the Service cell in the rule contains a Service that uses a Protocol Agent, the NGFW Engine also validates the traffic on the application layer. If a protocol violation occurs, the packet that violates the protocol is dropped.</li> </ul>

Option	Definition
<b>Idle Timeout</b>	The timeout (in seconds) after which inactive connections are closed. This timeout concerns only idle connections. Connections are not cut because of timeouts while the hosts are still communicating.  If you enter a timeout, this value overrides the setting defined in the NGFW Engine properties.
<b>Sync Connections</b>	This option is not yet supported.
<b>TCP MSS</b>	When selected, TCP MSS is enforced. Headers are not included in the maximum segment size (MSS) value; MSS concerns only the payload of the packet. Usually, network equipment sends packets at the Ethernet-standard maximum transmission unit (MTU) size of 1500 (including both payload and headers). <ul style="list-style-type: none"> <li>■ <b>Min</b> — If a TCP packet has an MSS value smaller than the minimum you set here, the packet is dropped. The smaller the data content is, the less efficient the communications become due to the fixed-size headers. Limiting the minimum size can help alleviate certain types of network attacks. Typically, the value you enter is not larger than the default minimum TCP Maximum Segment Size (536).</li> <li>■ <b>Max</b> — If a TCP packet has an MSS value larger than the maximum, the NGFW Engine overwrites the packet's MSS with the maximum value you set here. Setting the maximum MSS size might be necessary to prevent fragmentation. Typically, the value you enter is lower than the standard Ethernet MTU (1500), taking the packet headers that are added to the MSS into account.</li> </ul>
<b>Decryption</b>	This option is not yet supported.

## Edit the NAT policy

The NAT policy defines how network address translation (NAT) is applied to traffic.

The NAT policy does not contain any rules by default.

### Steps

- 1) Browse to **NGFW > Policy > NAT**.
- 2) Add a rule in one of the following ways:
  - Click **+ Add First Rule**.
  - Click a rule, select **⋮ > New**, then select **Rule Before** or **Rule After**.
- 3) Configure the settings, then click **Save**.
- 4) Publish the changes.

Fields marked with an asterisk **\*** in the user interface are mandatory.

NAT Policy	
Option	Definition
<b>NAT Service</b>	A set of matching criteria that matches traffic based on the protocol and port.



Option	Definition
<b>NAT Source</b>	<p>A set of matching criteria that defines the source IP addresses and interfaces that the rule matches.</p> <ul style="list-style-type: none"> <li>■ <b>NAT Source</b> — When selected, enables options in the cell.</li> <li>■ Type part of the name of an element or browse through the drop-down list to select an element.</li> <li>■ Click <b>Set to ANY</b> to match any element.</li> <li>■ <b>NAT Proxy ARP</b> — When selected, allows the engine to answer address queries regarding the translated addresses.</li> </ul>
<b>NAT Source Translation</b>	<p>Defines the options for NAT source translation.</p> <ul style="list-style-type: none"> <li>■ <b>NAT Source</b> — When selected, enables the options in the cell.</li> <li>■ <b>NAT Type</b> <ul style="list-style-type: none"> <li>■ <b>Static</b> — Source addresses in matching connections are translated using the same number of IP addresses as there are possible original source addresses. Each translated IP address corresponds to one original IP address.</li> <li>■ <b>Dynamic</b> — Source addresses in matching connections are translated using a smaller pool of IP addresses than there are original source addresses included in the rule. Many hosts can use the same IP address, and the connections are distinguished by allocating a different TCP or UDP port for each connection.</li> </ul> </li> <li>■ <b>NAT IP Address</b> <ul style="list-style-type: none"> <li>■ <b>Any</b> — This option is not yet supported.</li> <li>■ <b>IP Address</b> — The original IP address is translated to the specified IP address.</li> <li>■ <b>Element</b> — The original IP address is translated to the IP address of the selected Network element.</li> </ul> </li> <li>■ <b>Port Range</b> — When selected, specifies the port range for dynamic IP address translation. <ul style="list-style-type: none"> <li>■ <b>Min</b> — The start of the port range for IP address translation.</li> <li>■ <b>Max</b> — The end of the port range for IP address translation.</li> </ul> </li> </ul>
<b>NAT Destination</b>	<p>A set of matching criteria that defines the destination IP addresses and interfaces that the rule matches and defines the options for NAT destination translation.</p> <ul style="list-style-type: none"> <li>■ <b>NAT Destination</b> — When selected, enables the options in the cell.</li> <li>■ Type part of the name of an element or browse through the drop-down list to select an element.</li> <li>■ Click <b>Set to ANY</b> to match any element.</li> <li>■ <b>NAT IP Address</b> <ul style="list-style-type: none"> <li>■ <b>Any</b> — This option is not yet supported.</li> <li>■ <b>IP Address</b> — The original IP address is translated to the specified IP address.</li> <li>■ <b>Element</b> — The original IP address is translated to the IP address of the selected Network element.</li> </ul> </li> <li>■ <b>Port Range</b> — When selected, specifies the port range for dynamic IP address translation. <ul style="list-style-type: none"> <li>■ <b>Min</b> — The start of the port range for IP address translation.</li> <li>■ <b>Max</b> — The end of the port range for IP address translation.</li> </ul> </li> <li>■ <b>NAT Proxy ARP</b> — When selected, allows the engine to answer address queries regarding the translated addresses.</li> </ul>

# Select the Inspection policy for the NGFW Engine

The Inspection policy defines how the engines look for patterns in traffic allowed by the Access policy and what happens when a certain type of pattern is found.



## Note

Creating custom Inspection Policies is an advanced feature. We recommend using one of the default Inspection Policy elements.

## Steps

- 1) Browse to **NGFW > Properties > Policies**.
- 2) Click the **Inspection Policy** field, then select an Inspection Policy element.  
Type part of the name of an element or browse through the drop-down list to select an element.
- 3) Click **Save**.
- 4) Publish the changes.

# Configure SSH access to the NGFW Engine command line

To allow secure remote connections to the command line of the NGFW Engine, configure SSH access.

## Before you begin

Create Host or Network elements to define the IP addresses from which SSH connections to the NGFW Engine are allowed.

## Steps

- 1) Browse to **NGFW > Properties > General**.
- 2) Select **SSH Server Enabled**.
- 3) Browse to **NGFW > Properties > Policies**.
- 4) In the **Alias Resolving** settings, click **...** > **Add**.

- Define the following alias translation:

Alias	Alias Value
\$ Allowed SSH Remote Sources	The Host or Network elements that represent the IP addresses from which SSH connections to the NGFW Engine are allowed.

Type part of the name of an element or browse through the drop-down list to select an element.

- Click **Save**.
- Publish the changes.

## Configure NTP

Network time protocol (NTP) servers provide time synchronization for the NGFW Engine.



### Note

This feature requires Internet connectivity.

### Steps

- Create an NTP Server element.  
This element can be found under **Elements > Network Elements > Server**.
- Browse to **NGFW > Properties > General**.
- Click the **NTP Servers** field, then select the NTP Server element.  
Type part of the name of an element or browse through the drop-down list to select an element.
- Click **Save**.
- Publish the changes.

Fields marked with an asterisk \* in the user interface are mandatory.

NTP Server element	
Option	Definition
IP List	The IP addresses of the NTP server. You must enter either an IP address or a host name. Enter one IP address per row. If you have a list of IP addresses where each IP address is on a separate row, you can copy and paste the list. To remove a row, click <b>Remove</b> next to the row. To remove all rows, click <b>Clear All</b> .
Hostname	The host name of the NTP server. You must enter either an IP address or a host name.
NTP Key Type	<ul style="list-style-type: none"> <li><b>None</b> — The NTP Server does not use a key.</li> <li><b>MD5</b> — The NTP Server uses an MD5 hash.</li> <li><b>SHA-1</b> — The NTP Server uses an SHA-1 hash.</li> </ul>

Option	Definition
Key ID	(When <i>NTP Key Type</i> is <i>MD5</i> or <i>SHA-1</i> ) Specifies a unique identifier for the key. Enter a value between 1—65534.
Key MD5 or Key SHA-1	(When <i>NTP Key Type</i> is <i>MD5</i> or <i>SHA-1</i> ) Specifies the MD5 or SHA-1 hash.

## Configure DNS

The NGFW Engine uses domain name system (DNS) servers to resolve domain names to IP addresses.



### Note

This feature requires Internet connectivity.

The NGFW Engine needs DNS resolution to contact services that are defined using URLs or domain names, and to resolve fully qualified domain names (FQDNs) used in policies.

There are two ways to define DNS servers:

- You can create reusable DNS Server elements.
- You can add the IP addresses of DNS servers directly to the NGFW Engine properties.

You can add several DNS servers to the NGFW Engine. The NGFW Engine uses the DNS servers in the order that they are listed. If the first DNS server is not available, the NGFW Engine uses the next DNS server in the list.

### Steps

- 1) (Optional) Create a DNS Server element.  
This element can be found under **Elements > Network Elements > Server**.
- 2) Browse to **NGFW > Properties > General**.
- 3) In the **DNS Servers** field, define the DNS server in one of the following ways:
  - Select **⋮ > New > Element**, then click the **Element** field and select the DNS Server element. Type part of the name of an element or browse through the drop-down list to select an element.
  - Select **⋮ > New > Address**, then enter the IP address of the DNS server.
- 4) Click **Save**.
- 5) Publish the changes.

Fields marked with an asterisk **\*** in the user interface are mandatory.

DNS Server element	
Option	Definition
IP List	The IP addresses of the DNS server. Enter one IP address per row. If you have a list of IP addresses where each IP address is on a separate row, you can copy and paste the list. To remove a row, click  <b>Remove</b> next to the row. To remove all rows, click <b>Clear All</b> .
Time To Live	Defines how long a DNS entry can be cached before querying the DNS server again.
Update Interval	Defines how often the DNS entries can be updated to the DNS server if the link status changes constantly.

## Configure the NGFW Engine tester

The NGFW Engine tester runs various checks on the NGFW Engine and initiates responses based on the success or failure of these tests.

The following tests are available:

- Engine Properties Test External — Runs a command or custom script stored on the NGFW Engine. If the command or script returns the code zero (0), the test is considered successful, otherwise the test is considered failed.
- Engine Properties Test File Space — Checks the free disk space on a hard disk partition.
- Engine Properties Test Swap Space — Checks the available swap space on the hard disk.
- Engine Properties Test Inline Link — Checks whether the network settings (speed/duplex) match on the two ports that form the inline pair and can force ports to use the same settings.



### Note

Inline interfaces are not yet supported on the NGFW Manager.

- Engine Properties Test Link Status — Checks whether a network port reports the link as up or down.
- Engine Properties Test Multiping — Sends out a series of ping requests to determine whether there is connectivity through a network link.

The results of the tests are shown in the Logs view.

### Steps



- 1) Browse to **NGFW > Properties > General**.
- 2) Select **Tester Parameters**, then configure the global tester settings.
- 3) To add a new test, do the following:
  - a) Click **New**.
  - b) Click the cell in the **Test** column.
  - c) Click **New**, then select the test that you want to add.
  - d) Configure the test-specific settings, then click **Save**.

- 4) To delete a test, select the row, then select **...** > **Delete**.
- 5) To temporarily deactivate a test without deleting it, select the cell in the **Active** column, then deselect the **Active** option.
- 6) Click **Save**.
- 7) Publish the changes.

Fields marked with an asterisk \* in the user interface are mandatory.

NGFW > Status > General	
Option	Definition
<b>Tester Parameters</b>	When selected, you can configure the global tester parameters.
<b>Alert Interval</b>	Specify the time in minutes the NGFW Engine waits before sending a new alert when the same test keeps failing repeatedly. The default value is 60 minutes. If the interval is too short, the alerts can overload the system or the alert recipient.
<b>Delay After Boot</b>	Specify the time in seconds that the NGFW Engine waits before it resumes running the tests after the NGFW Engine starts. The delay prevents false test failures that can occur due to variations in how quickly different processes and subsystems can start and stop. The maximum value is 1800.
<b>Delay After Reconfiguration</b>	Specify the time in seconds that the NGFW Engine waits before it resumes running the tests after the NGFW Engine is reconfigured. The delay prevents false test failures that can occur due to variations in how quickly different processes and subsystems can start and stop. The maximum value is 1800.
<b>Delay After Status Change</b>	Specify the time in seconds that the NGFW Engine waits before it resumes running the tests after the status of the NGFW Engine changes. The delay prevents false test failures that can occur due to variations in how quickly different processes and subsystems can start and stop. The maximum value is 1800.
<b>Is Auto Recovery</b>	When selected, the NGFW Engine automatically goes back online when a previously failed test completes successfully. Run the test in both online and offline states if you activate this option.
<b>Is Boot Recovery</b>	When selected, the NGFW Engine automatically goes back online after restarting if all offline tests report a success.

Engine Properties Test External dialog box	
Option	Definition
<b>Name</b>	The name of the test. If you want to run more than one instance of the same test type with different parameters, give each test a unique name.
<b>Description</b>	An optional description of the test.
<b>Is Run Online</b>	When selected, the test is run when the NGFW Engine node is online.
<b>Is Run Offline</b>	When selected, the test is run when the NGFW Engine node is offline.
<b>Is Run Standby</b>	This option is only available for clusters. Clusters are not yet supported on the NGFW Manager.
<b>Test Interval</b>	Specify how frequently the test is run. The minimum interval is one second and the maximum is 86400 (one day). We recommend a minimum interval of four seconds. Running a test too frequently can increase overhead.

Option	Definition
<b>Action in Failure</b>	<p>Select the action taken if a test fails.</p> <ul style="list-style-type: none"> <li>■ <b>None</b> — No action is taken.</li> <li>■ <b>Offline</b> — This option is only available for clusters. Clusters are not yet supported on the NGFW Manager.</li> <li>■ <b>Force Offline</b> — The NGFW Engine goes offline.</li> </ul> <div style="border: 1px solid #ccc; padding: 5px; margin-top: 10px;"> <p> <b>Note</b></p> <p>To bring the NGFW Engine back online, you must enter <code>sg-cluster online</code> on the command line.</p> </div>
<b>Is Alert</b>	When selected, sends an alert to notify administrators that a test has failed.
<b>Retry Count</b>	Enter the number of times the tester tries to execute the test. We recommend always setting the retry count to more than 1 to avoid creating overly sensitive tests that burden the system unnecessarily.
<b>Timeout</b>	Enter the timeout in milliseconds. If the test being run does not return a response in the specified time, the test has failed. Avoid overly short timeout values. We recommend a timeout of 500–1000 ms, depending on the test.
<b>Command Line</b>	<p>Enter the command or script path. The result must return an exit code of 0 (zero) if it succeeds. Any non-zero return value is a failure.</p> <p>Example:</p> <div style="border: 1px solid #ccc; padding: 5px; margin-top: 10px;"> <pre>/data/home/root/connectivity.sh</pre> </div> <p>You can add multiple commands. To remove a row, click  <b>Remove</b> next to the row. To remove all rows, click <b>Clear All</b>.</p>

#### Engine Properties Test File Space dialog box

Option	Definition
<b>Name</b>	The name of the test. If you want to run more than one instance of the same test type with different parameters, give each test a unique name.
<b>Description</b>	An optional description of the test.
<b>Is Run Online</b>	When selected, the test is run when the NGFW Engine node is online.
<b>Is Run Offline</b>	When selected, the test is run when the NGFW Engine node is offline.
<b>Is Run Standby</b>	This option is only available for clusters. Clusters are not yet supported on the NGFW Manager.
<b>Test Interval</b>	Specify how frequently the test is run. The minimum interval is one second and the maximum is 86400 (one day). We recommend a minimum interval of four seconds. Running a test too frequently can increase overhead.



Option	Definition
<b>Action in Failure</b>	Select the action taken if a test fails. <ul style="list-style-type: none"> <li>■ <b>None</b> — No action is taken.</li> <li>■ <b>Offline</b> — This option is only available for clusters. Clusters are not yet supported on the NGFW Manager.</li> <li>■ <b>Force Offline</b> — The NGFW Engine goes offline.</li> </ul> <div style="border: 1px solid #ccc; padding: 5px; margin-top: 10px;">  <p><b>Note</b></p> <p>To bring the NGFW Engine back online, you must enter <code>sg-cluster online</code> on the command line.</p> </div>
<b>Is Alert</b>	When selected, sends an alert to notify administrators that a test has failed.
<b>Partition</b>	Specify the partition to test.
<b>Free File Space</b>	Enter the minimum amount of free space in kilobytes. When the amount of free space drops below this amount, the NGFW Engine executes the chosen action.

#### Engine Properties Test Swap Space dialog box

Option	Definition
<b>Name</b>	The name of the test. If you want to run more than one instance of the same test type with different parameters, give each test a unique name.
<b>Description</b>	An optional description of the test.
<b>Is Run Online</b>	When selected, the test is run when the NGFW Engine node is online.
<b>Is Run Offline</b>	When selected, the test is run when the NGFW Engine node is offline.
<b>Is Run Standby</b>	This option is only available for clusters. Clusters are not yet supported on the NGFW Manager.
<b>Test Interval</b>	Specify how frequently the test is run. The minimum interval is one second and the maximum is 86400 (one day). We recommend a minimum interval of four seconds. Running a test too frequently can increase overhead.
<b>Action in Failure</b>	Select the action taken if a test fails. <ul style="list-style-type: none"> <li>■ <b>None</b> — No action is taken.</li> <li>■ <b>Offline</b> — This option is only available for clusters. Clusters are not yet supported on the NGFW Manager.</li> <li>■ <b>Force Offline</b> — The NGFW Engine goes offline.</li> </ul> <div style="border: 1px solid #ccc; padding: 5px; margin-top: 10px;">  <p><b>Note</b></p> <p>To bring the NGFW Engine back online, you must enter <code>sg-cluster online</code> on the command line.</p> </div>
<b>Is Alert</b>	When selected, sends an alert to notify administrators that a test has failed.
<b>Free Swap Space</b>	Enter the minimum amount of free space in kilobytes. When the amount of free space drops below this amount, the NGFW Engine executes the chosen action.



**Engine Properties Test Inline Link dialog box**

Option	Definition
	<p><b>Note</b></p> <p>Inline interfaces are not yet supported on the NGFW Manager.</p>
<b>Name</b>	The name of the test. If you want to run more than one instance of the same test type with different parameters, give each test a unique name.
<b>Description</b>	An optional description of the test.
<b>Is Run Online</b>	When selected, the test is run when the NGFW Engine node is online.
<b>Is Run Offline</b>	When selected, the test is run when the NGFW Engine node is offline.
<b>Is Run Standby</b>	This option is only available for clusters. Clusters are not yet supported on the NGFW Manager.
<b>Test Interval</b>	Specify how frequently the test is run. The minimum interval is one second and the maximum is 86400 (one day). We recommend a minimum interval of four seconds. Running a test too frequently can increase overhead.
<b>Action in Failure</b>	<p>Select the action taken if a test fails.</p> <ul style="list-style-type: none"> <li>■ <b>None</b> — No action is taken.</li> <li>■ <b>Offline</b> — This option is only available for clusters. Clusters are not yet supported on the NGFW Manager.</li> <li>■ <b>Force Offline</b> — The NGFW Engine goes offline.</li> </ul> <p> <b>Note</b></p> <p>To bring the NGFW Engine back online, you must enter <code>sg-cluster online</code> on the command line.</p>
<b>Is Alert</b>	When selected, sends an alert to notify administrators that a test has failed.
<b>Inline Link Timeout</b>	Enter the timeout in milliseconds. If the test being run does not return a response in the specified time, the test has failed. Avoid overly short timeout values.

**Engine Properties Test Link Status dialog box**

Option	Definition
<b>Name</b>	The name of the test. If you want to run more than one instance of the same test type with different parameters, give each test a unique name.
<b>Description</b>	An optional description of the test.
<b>Is Run Online</b>	When selected, the test is run when the NGFW Engine node is online.
<b>Is Run Offline</b>	When selected, the test is run when the NGFW Engine node is offline.
<b>Is Run Standby</b>	This option is only available for clusters. Clusters are not yet supported on the NGFW Manager.
<b>Test Interval</b>	Specify how frequently the test is run. The minimum interval is one second and the maximum is 86400 (one day). We recommend a minimum interval of four seconds. Running a test too frequently can increase overhead.

Option	Definition
<b>Action in Failure</b>	<p>Select the action taken if a test fails.</p> <ul style="list-style-type: none"> <li>■ <b>None</b> — No action is taken.</li> <li>■ <b>Offline</b> — This option is only available for clusters. Clusters are not yet supported on the NGFW Manager.</li> <li>■ <b>Force Offline</b> — The NGFW Engine goes offline.</li> </ul> <div style="border: 1px solid #ccc; padding: 5px; margin-top: 10px;"> <p> <b>Note</b></p> <p>To bring the NGFW Engine back online, you must enter <code>sg-cluster online</code> on the command line.</p> </div>
<b>Is Alert</b>	When selected, sends an alert to notify administrators that a test has failed.
<b>Link Scope</b>	<p>Select the interface on which the test is run.</p> <ul style="list-style-type: none"> <li>■ <b>All</b> — All physical, modem, ADSL, and wireless interfaces.</li> <li>■ <b>All With CVI</b> — This option is only available for clusters. Clusters are not yet supported on the NGFW Manager.</li> <li>■ <b>Specific</b> — A specific physical interface only.</li> </ul>
<b>Physical Interface</b>	<p>(When <i>Link Scope</i> is <i>Specific</i>)</p> <p>Select the physical interface to run the test on.</p>

#### Engine Properties Test Multiping dialog box

Option	Definition
<b>Name</b>	The name of the test. If you want to run more than one instance of the same test type with different parameters, give each test a unique name.
<b>Description</b>	An optional description of the test.
<b>Is Run Online</b>	When selected, the test is run when the NGFW Engine node is online.
<b>Is Run Offline</b>	When selected, the test is run when the NGFW Engine node is offline.
<b>Is Run Standby</b>	This option is only available for clusters. Clusters are not yet supported on the NGFW Manager.
<b>Test Interval</b>	Specify how frequently the test is run. The minimum interval is one second and the maximum is 86400 (one day). We recommend a minimum interval of four seconds. Running a test too frequently can increase overhead.
<b>Action in Failure</b>	<p>Select the action taken if a test fails.</p> <ul style="list-style-type: none"> <li>■ <b>None</b> — No action is taken.</li> <li>■ <b>Offline</b> — This option is only available for clusters. Clusters are not yet supported on the NGFW Manager.</li> <li>■ <b>Force Offline</b> — The NGFW Engine goes offline.</li> </ul> <div style="border: 1px solid #ccc; padding: 5px; margin-top: 10px;"> <p> <b>Note</b></p> <p>To bring the NGFW Engine back online, you must enter <code>sg-cluster online</code> on the command line.</p> </div>
<b>Is Alert</b>	When selected, sends an alert to notify administrators that a test has failed.
<b>Retry Count</b>	Enter the number of times the tester tries to execute the test. We recommend always setting the retry count to more than 1 to avoid creating overly sensitive tests that burden the system unnecessarily.

Option	Definition
<b>Timeout</b>	Enter the timeout in milliseconds. If the test being run does not return a response in the specified time, the test has failed. Avoid overly short timeout values. We recommend a timeout of 500–1000 ms, depending on the test.
<b>Target Addresses</b>	Enter the IP addresses that you want to ping. Enter one IP address per row. If you have a list of IP addresses where each IP address is on a separate row, you can copy and paste the list.  To remove a row, click  <b>Remove</b> next to the row. To remove all rows, click <b>Clear All</b> .
<b>Source Address</b>	Select the IP address to use as the source.

## Change the IP address of the interface for control connections

By default, the interface for control connections has an IP address and network configured. You can optionally change the IP address.

### Before you begin

Decide what IP address to use as the IP address of the interface for control connections, then make a note of the IP address.

The IP address of the interface for control connections has the following restrictions:

- Only Node Dedicated IP addresses (NDIs) are supported.
- Only IPv4 addresses are supported.
- The interface for control connections can only have one IP address.



#### CAUTION

Do not add additional IP addresses or VLANs to the interface for control connections.

### Steps

- 1) Browse to **NGFW > Interfaces**.
- 2) In the interface table below the appliance image, click the interface for control connections, then select **Remove IP Address and Network**.  
The interface for control connections is indicated with the text (Control) after the IP address.
- 3) Click the same interface, then select **Add IP Address and Network**.
- 4) Enter the IP address and netmask in CIDR notation, then click **Save**.  
Example: 192.168.1.1/24
- 5) Click the IP address, then select **Properties: Static Address**.

- 6) Select **Primary Mgt**, then click **Save**.
- 7) Continue the configuration in one of the following ways:
  - If you are configuring interfaces for the first time, click:

**Finalize the setup**

- Otherwise, click:

**Publish Changes**

When you publish the changes, your connection to the NGFW Manager is interrupted because the IP address to which you are connected is no longer available.

- 8) Log on to the NGFW Manager at the new IP address.  
Example: `https://192.168.1.1/#/en/ngfw/status`

Fields marked with an asterisk \* in the user interface are mandatory.

Properties: Static Address	
Option	Definition
Is Used in Antispoofing	When selected, the IP address is included in the antispoofing configuration. Keep this option selected.
CVI	This option is not yet supported.
NDI	When selected, the NGFW Engine node has a dedicated IP address. Keep this option selected.
Primary Mgt	When selected, the IP address is used for control connections to the NGFW Manager interface.



## Create other elements for NGFW Engine configuration

Configurations are stored as reusable elements. Different element types are provided for different concepts. For most elements, you can enter an optional name and comment to help you identify the elements that you create.

### Steps

- 1) Browse to **Elements** > <element category> > <element type>.
- 2) Click **New**.
- 3) Configure the settings, then click **Save**.
- 4) Publish the changes.

Fields marked with an asterisk \* in the user interface are mandatory.

Elements tab	
Option	Definition
<b>Network Elements</b>	Represent the IP addresses used in policies and in the NGFW Engine properties.
<b>Policies</b>	The rules for inspecting and handling network traffic.
<b>Network Applications</b>	<p>Provide a way to dynamically identify traffic patterns related to the use of a particular application. Network Applications are used in the Access policy to match traffic.</p> <div style="border: 1px solid #ccc; background-color: #f9f9f9; padding: 5px; margin-top: 10px;"> <p> <b>Note</b> It is not possible to create new elements of this type.</p> </div>
<b>Services</b>	Represent the network protocols and ports used in policies. Service elements are used in the Access policy and the NAT policy to match traffic.
<b>Situations</b>	<p>Patterns that deep inspection looks for in traffic. Situation elements are used in the Inspection policy.</p> <div style="border: 1px solid #ccc; background-color: #f9f9f9; padding: 5px; margin-top: 10px;"> <p> <b>Note</b> It is not possible to create new elements of this type.</p> </div>
<b>File Types</b>	<p>Represent different types of files that can be allowed or blocked.</p> <div style="border: 1px solid #ccc; background-color: #f9f9f9; padding: 5px; margin-top: 10px;"> <p> <b>Note</b> It is not possible to create new elements of this type.</p> </div>
<b>TLS</b>	These elements are not yet supported.
<b>Other Elements</b>	These elements are not yet supported.



# Monitoring the NGFW Engine

### Contents

- [Browse log data on page 103](#)

Log and alert entries provide information about what is going on in your network environment.

Log and alert entries are most often triggered by rules in the Access policy. Other types of rules can also be configured to create log and alert entries.



#### Note

This document describes the currently supported features and options. Some features and options that are not yet supported might appear in the user interface.

## Browse log data

Copies of the most recent log and alert entries are stored on the NGFW Engine.

### Steps

- 1) Browse to **NGFW > Logs**.  
Log events are shown in real time as they are created.
- 2) To view earlier log events, scroll up in the table.

Log Events	
Option	Definition
Kind	The type of policy that triggered the log event.
Creation Time	Log entry creation time.
Component ID	The identifier of the creator of the log entry.
Event ID	Event identifier, unique within one sender.
Sender	IP address of the NGFW Engine that sent the log entry.
Information Message	A description of the log event that further explains the entry.
Facility	The NGFW Engine subsystem that generated the log event.
Type	Log entry severity type.
Action	Action of the rule that triggered the log event. The action values are Allow, Discard, Refuse, Terminate, Wait for further actions, and Wait for authentication.
Rule Tag	Rule tag of the rule that triggered the log event.

Option	Definition
<b>Src Addr</b>	Packet source IP address.
<b>Dst Addr</b>	Packet destination IP address.
<b>Src Port</b>	TCP or UDP source port in the packet header.
<b>Dst Port</b>	TCP or UDP destination port in the packet header.
<b>IP Protocol</b>	IP protocol of the traffic that generated the log event.
<b>IP Version</b>	Version field value in the IP header.
<b>Event</b>	The event that triggered the log creation, for example, New connection, Connection closed, Connection discarded.
<b>Situation</b>	The identifier of the situation that triggered the log event.
<b>Syslog</b>	Syslog is a system service used in some operating systems, for example, UNIX, and software packages. For more information about syslog and syslog types, see RFC 3164.
<b>Daemon</b>	The name of the daemon that generated the log event.



## Chapter 6

# Configuring other NGFW Engine properties

### Contents

- Configure general settings for the NGFW Engine on page 105
- Configure policy settings for the NGFW Engine on page 106
- VPN settings for the NGFW Engine on page 108
- Add-ons for the NGFW Engine on page 108

You can optionally configure other NGFW Engine properties if necessary.



#### Note

This document describes the currently supported features and options. Some features and options that are not yet supported might appear in the user interface.

## Configure general settings for the NGFW Engine

General settings include high-level properties of the NGFW Engine, and settings for NTP and DNS.

### Steps

- 1) Browse to **NGFW > Properties > General**.
- 2) Configure the settings, then click **Save**.
- 3) Publish the changes.

Fields marked with an asterisk \* in the user interface are mandatory.

#### NGFW Engine Properties - General

Option	Definition
<b>NTP Server</b>	Specifies the NTP Server element that the NGFW Engine uses.
<b>DNS Servers</b>	Specifies the DNS Server elements or IP addresses of the DNS servers that the NGFW Engine uses. The NGFW Engine uses the DNS servers in the order that they are listed. If the first DNS server is not available, the NGFW Engine uses the next DNS server in the list.
<b>SSH Server Enabled</b>	When selected, SSH access to the command line of the NGFW Engine is enabled. You must separately specify the IP addresses that are allowed to connect to the NGFW Engine using SSH.

Option	Definition
Keyboard Layout	This option is not yet supported.
Timezone	This option is not yet supported.
Main Physical Interface	This option is not yet supported.
Diagnostics	Select from the following: <ul style="list-style-type: none"> <li>■ <b>Authentication</b> — When selected, authentication diagnostic information is included in log data.</li> <li>■ <b>IPsec</b> — When selected, IPsec VPN diagnostic information is included in log data.</li> </ul>
Log Forwarder	This option is not yet supported.
Tester Parameters	When selected, you can configure the global settings for the NGFW Engine tester.
Tests	Shows the configured NGFW Engine tests. To add a row to the list, click <b>New</b> .

### Related tasks

[Configure NTP on page 91](#)

[Configure DNS on page 92](#)

[Configure SSH access to the NGFW Engine command line on page 90](#)

[Configure the NGFW Engine tester on page 93](#)

# Configure policy settings for the NGFW Engine

Policy settings specify which policies the NGFW Engine uses, as well as settings for element-based NAT, alias translation, and automatic rules.

## Steps

- 1) Browse to **NGFW > Properties > Policies**.
- 2) Configure the settings, then click **Save**.
- 3) Publish the changes.

Fields marked with an asterisk \* in the user interface are mandatory.

NGFW Engine Properties - Policies	
Option	Definition
Layer3 Policy	The selected Layer 3 Policy for the NGFW Engine. We recommend that you do not change this setting.
Inspection Policy	The selected Inspection Policy for the NGFW Engine.
File Filtering Policy	This option is not yet supported.
NAT Definition	When selected, enables options for element-based NAT.

Option	Definition
<b>Alias Resolving</b>	<p>Click <b>*** &gt; Add</b> to add the first row.</p> <p>Click <b>New &gt; Row Before</b> or <b>New &gt; Row After</b> to add more rows.</p> <ul style="list-style-type: none"> <li>■ <b>Alias</b> — The Alias element. Type part of the name of an element or browse through the drop-down list to select an element.</li> <li>■ <b>Alias Value</b> — The translated value of the Alias element. Type part of the name of an element or browse through the drop-down list to select an element.</li> </ul>
<b>Automatic Rules Settings</b>	When selected, enables options for automatic rules.

#### NGFW Engine Properties - Policies - NAT Definition

Option	Definition
<b>NAT Element Array</b>	Click <b>*** &gt; Add</b> to add definitions for element-based NAT.
<b>NAT Type</b>	<p>Select the translation type.</p> <ul style="list-style-type: none"> <li>■ <b>Static</b> — Static network address translation is used. For each original address there is a single, predefined translated address.</li> <li>■ <b>Dynamic</b> — Dynamic network address translation is used. Dynamic NAT uses ports to track connections using the same IP address.</li> </ul>
<b>NAT Address Private</b>	The element that represents the private IP address. Type part of the name of an element or browse through the drop-down list to select an element.
<b>NAT Address Public</b>	<p>Select the source of the public IP address.</p> <ul style="list-style-type: none"> <li>■ <b>NAT Default</b> — The default address is used as the public IP Address.</li> <li>■ <b>IP Address</b> — Enter an IP address.</li> <li>■ <b>NAT Interface Addr</b> — Click <b>+</b>, then select an interface.</li> <li>■ <b>Element</b> — Type part of the name of an element or browse through the drop-down list to select an element.</li> </ul>
<b>NAT Port Filter</b>	To limit NAT only to traffic that goes to selected destination ports, select a Service or Service Group element to act as a port filter. The Service or Service Group element includes the destination port information (a single destination port or a range of ports). Type part of the name of an element or browse through the drop-down list to select an element.
<b>NAT Default Enabled</b>	The NGFW Engine uses the default NAT address as the public IP address if there is not a more specific NAT definition that matches the traffic. When you select this option, a NAT rule is generated at the end of the NAT rules in the policy. If no NAT rule matches the traffic, no NAT is applied unless you enable the Default NAT Address.

#### NGFW Engine Properties - Policies - Automatic Rules Settings

Option	Definition
<b>Logging</b>	When selected, enables the logging options.

Option	Definition
<b>Log Level</b>	<p>The log level for traffic that matches automatic rules.</p> <ul style="list-style-type: none"> <li>■ <b>None</b> — Does not create any log entry</li> <li>■ <b>Transient</b> — Creates a log entry that is shown on the Logs tab, but is not stored.</li> <li>■ <b>Stored</b> — Creates a log entry that is stored on the NGFW Engine.</li> <li>■ <b>Essential</b> — Creates a log entry that is shown on the Logs tab and saved for further use.</li> <li>■ <b>Alert</b> — Triggers an alert with the severity that you define.</li> <li>■ <b>Automatic</b> — This option is not supported in the Access policy.</li> </ul>
<b>Severity</b>	<p>When the <b>Log Level</b> is set to <b>Alert</b>, defines the severity of the alert.</p>
<b>Connection Closing</b>	<p>Specifies how log entries are created when connections are closed.</p> <ul style="list-style-type: none"> <li>■ <b>None</b> — No log entries are created.</li> <li>■ <b>Normal</b> — Both connection opening and closing are logged, but no information about the volume of traffic is collected.</li> <li>■ <b>Accounting</b> — Both connection opening and closing are logged and information about the volume of traffic is collected.</li> </ul>
<b>Log User</b>	<p>Defines whether information about users is included in the log data.</p> <ul style="list-style-type: none"> <li>■ <b>Off</b> — Information about users is not included in the log data.</li> <li>■ <b>Default</b> — Information about users is included in the log data if information about the user is cached for the connection. Otherwise, only the IP address associated with the user at the time the log is created is included in the log data. Access control by user must be enabled.</li> <li>■ <b>Enforced</b> — Information about users is always included in the log data if information about the user is available in the user database. If information about the user is not cached for the connection, the NGFW Engine resolves the user information from the IP address. Access control by user must be enabled.</li> </ul>
<b>Log URL Category</b>	<p>Defines whether information about URL categorization is included in the log data.</p> <ul style="list-style-type: none"> <li>■ <b>Off</b> — URL categories are not included in the log data.</li> <li>■ <b>Default</b> — URL categories are included in the log data for matching traffic when URL Categories are used as matching criteria in the rule.</li> <li>■ <b>Enforced</b> — URL categories are always included in the log data if the URL category can be identified.</li> </ul>

## VPN settings for the NGFW Engine

VPN settings are not yet supported in NGFW Engine Management mode.

## Add-ons for the NGFW Engine

Add-ons are not yet supported.

# Part IV

## Maintenance

### Contents

- [Maintenance tasks on page 111](#)

Most maintenance tasks can be done for both the VPN Broker and for single NGFW Engines.



### Contents

- Upload, import, and activate dynamic update packages on page 111
- Upgrade a single NGFW Engine on page 112
- Change your password on page 114
- Export elements on page 114
- Import elements on page 115
- Back up system configurations on page 115
- Restore backups on page 116
- Restart the NGFW Engine on page 117
- Turn off the NGFW Engine on page 117
- Collect information for Forcepoint support on page 118
- Reset the NGFW appliance to default settings on page 118

Maintenance includes procedures that you do not typically need to do frequently.

## Upload, import, and activate dynamic update packages

The NGFW appliance is delivered with a dynamic update package. You can manually upload, import, and activate new dynamic update packages.

Only one dynamic update package at a time can be active.

### Steps

- 1) Go to <https://https://dep-downloads.ngfw.forcepoint.com>.
- 2) On the **LLM Dynamic Updates** tab, download the latest dynamic update package .zip file. For details about the dynamic update package, click **Release Notes** under the .zip file.
- 3) Save the update package file to a location accessible from the computer where you use the NGFW Manager.



#### Note

Make sure that the checksums for the original files and the files that you have downloaded match.

- In the NGFW Manager, select **NGFW > Status**.

### System Information

**Hostname**

Forcepoint-NGFW

**Model**

virtual\_appliance

**Installed Policy**

Initial Policy

**Update Package**

LLM Dynup 1222

[Manage...](#)

**Version**

6.8.0.24032

[Upgrade...](#)

- In the System Information pane, click **Manage** below the update package information.
- Click  **Upload dynup-file**, browse to the dynamic update file, then click **Open**.
- To import the dynamic update package, click **...** > **Import**.
- To activate the dynamic update package, click **...** > **Activate**.

Manage Update Packages	
Option	Definition
Update Package	Shows the name of the update package.
Creation Date	Shows the date that the update package was created.
State	Shows the status of the dynamic update package.
...	The following actions are available: <ul style="list-style-type: none"> <li>■ <b>Import</b> — Imports the uploaded dynamic update package.</li> <li>■ <b>Activate</b> — Activates the imported dynamic update package.</li> <li>■ <b>Delete</b> — Deletes the selected dynamic update package.</li> </ul>
 Upload dynup-file	Click to upload a dynamic update file to the NGFW Engine.

# Upgrade a single NGFW Engine

You can upgrade a single NGFW Engine using the NGFW Manager.



## Steps

- 1) Go to <https://support.forcepoint.com>.
- 2) Enter your license code or log on using an existing user account.
- 3) Select **Downloads**.
- 4) Under **Network Security**, click the version of the Forcepoint NGFW software that you want to download, then download the .zip file installation file.
- 5) Save the Forcepoint NGFW Engine upgrade file to a location accessible from the where computer you use the NGFW Manager.



### Note

Make sure that the checksums for the original files and the files that you have downloaded match.

- 6) In the NGFW Manager, select **NGFW > Status**.

### System Information

#### Hostname

Forcepoint-NGFW

#### Model

virtual\_appliance

#### Installed Policy

Initial Policy

#### Update Package

LLM Dynup 1222

[Manage...](#)

#### Version

6.8.0.24032

[Upgrade...](#)



- 7) In the System Information pane, click **Upgrade** below the version information.
- 8) Click **Upload software upgrade**, browse to the Forcepoint NGFW Engine upgrade file, then click **Open**.
- 9) Click **Upgrade**.

Software Upgrade	
Option	Definition
<b>Upload software upgrade</b>	Click to upload a Forcepoint NGFW Engine upgrade file.
<b>Upgrade</b>	Click to start the upgrade.

# Change your password

We recommend that you change your password regularly.

## Steps

- 1) Click  **User** >  **Change Password**.
- 2) Enter your current password, then enter and confirm the new password.
- 3) Click **Change Password**.

# Export elements

Exporting elements allows you to reuse or restore elements for single NGFW Engine configuration without having to create them again.



When you export elements, you can reuse elements in a different NGFW Manager or restore elements that have been deleted.



### Note

Exported files are meant for importing elements into the NGFW Manager. They are not meant to be viewed or edited in external applications.

## Steps

- 1) Click  **Actions** >  **Export Elements**.
- 2) Select the elements to export.
- 3) Click **Export**.

Export Elements	
Option	Definition
All elements	Exports all elements.
Choose elements	Allows you to select individual elements to export. Type part of the name of an element or browse through the drop-down list to select an element.
Export	Starts the export.

# Import elements

Importing elements allows you to reuse or restore elements for single NGFW Engine configuration without having to create them again.

## Before you begin

Export elements using the NGFW Manager.



### Note

You cannot import elements that were created using the SMC into the NGFW Manager.

## Steps

- 1) Click **Actions** > **Import Elements**.
- 2) Click **Select element archive**, then browse to the file that contains the exported elements.
- 3) Click **Import elements from archive**.  
The import starts.

# Back up system configurations

Backups contain the necessary configuration information to restore the NGFW Manager to the state it was in when the backup was taken.

By default, backup files are only stored on the NGFW Engine. We recommend downloading backup files to ensure that the backup files are available if the data on the NGFW Engine is lost.

## Steps

- 1) Click **Actions** > **Backups**.
- 2) Click **Create backup**.
- 3) (Optional) Enter a name for the backup.  
If you do not enter a name, the name is automatically generated.
- 4) Click **Create Backup**.  
The backup is created and appears in the list of available backups.

### Manage Backups

Option	Definition
Available backups	Shows backup files that have been created or uploaded to the NGFW Engine.

Option	Definition
...	<p>Actions related to backups.</p> <ul style="list-style-type: none"> <li>🔄 <b>Restore</b> — Replaces the current NGFW Manager configuration with the configuration from the backup.</li> <li>📁 <b>Download</b> — Saves the backup file on the computer where you are using the NGFW Manager.</li> <li>🗑️ <b>Delete</b> — Deletes the backup file from the NGFW Engine.</li> </ul>
🔄 <b>Create backup</b>	Creates a backup of the current NGFW Manager configuration.
📁 <b>Upload backup</b>	Uploads backup files to the NGFW Engine.

## Restore backups

Restoring backups allows you to recover from the loss of the system configurations.

### Before you begin

Back up system configurations.



#### CAUTION

Restoring a backup completely replaces the current NGFW Manager configuration with the configuration from the backup. Any elements or configurations that were created after the backup was made are deleted.

### Steps

- 1) Click **⋮ Actions > 📁 Backups**.
- 2) If the backup that you want to restore is not in the list of available backups, click **📁 Upload backup**, then browse to the backup file.  
The backup file is uploaded to the NGFW Engine.
- 3) Next to the backup that you want to restore, click **⋮ Actions > 🔄 Restore**.
- 4) When prompted to confirm, click **Restore Backup**.  
The current NGFW Manager configuration is replaced with the configuration from the backup.

# Restart the NGFW Engine

---

In rare cases, such as when the NGFW Engine is not functioning correctly, you might need to restart the NGFW Engine.



## Note

The NGFW Manager user interface is available only after the appliance has finished restarting.

## Steps

- 1) Browse to **NGFW > Status**.
- 2) Click **Restart Appliance**.  
You are prompted to confirm that you want to restart the appliance.
- 3) Click **Restart Now**.

## Result

The appliance restarts. Restarting might take some time.

# Turn off the NGFW Engine

---

You can turn off the NGFW Engine when moving the NGFW appliance to another location, or when doing hardware maintenance.



## Note

After you turn off the appliance, you must manually turn on the appliance before you can use it again.

## Steps

- 1) Browse to **NGFW > Status**.
- 2) Click **Turn off Appliance**.  
You are prompted to confirm that you want to turn off the appliance.
- 3) Click **Turn off Now**.

## Result

The appliance turns off.

# Collect information for Forcepoint support

When instructed to do so by Forcepoint support, you can collect information about the system to assist in troubleshooting.

## Steps

- 1) Browse to **NGFW > Status**.
- 2) Click **Information for Support**.  
You are prompted to confirm that you want to collect information for support.
- 3) Click **Get Information Now**.  
A file that contains information about the system is created.
- 4) Provide the file to Forcepoint support.

# Reset the NGFW appliance to default settings

We recommend resetting the NGFW appliance to default settings before disposing of the appliance, or mailing the appliance to Forcepoint support or another location.

Resetting the NGFW appliance to factory settings ensures that the NGFW appliance does not contain sensitive information.



### CAUTION

All data and settings are deleted when you reset the NGFW Engine to default settings.

## Steps

- 1) Browse to **NGFW > Status**.
- 2) Click **Reset to Default Settings**.  
You are prompted to confirm that you want to reset the NGFW Engine to default settings.
- 3) Click **Reset Now**.

## Result

All data and settings are deleted from the NGFW appliance.

